



STAR WARS



7877



WARNING: CHOKING HAZARD.
Toy contains small parts and a small ball.
Not for children under 3 years.

1

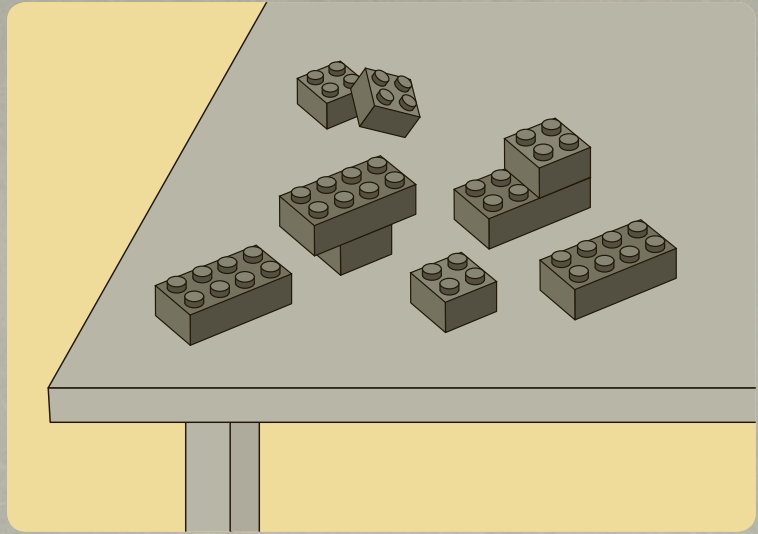
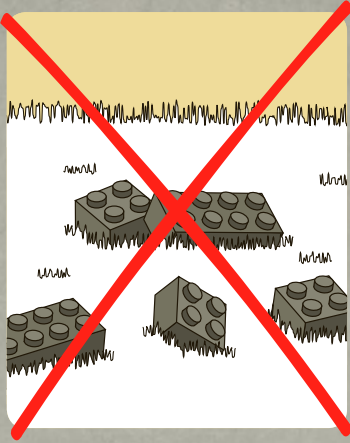

2





1



2

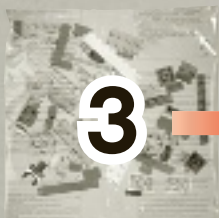
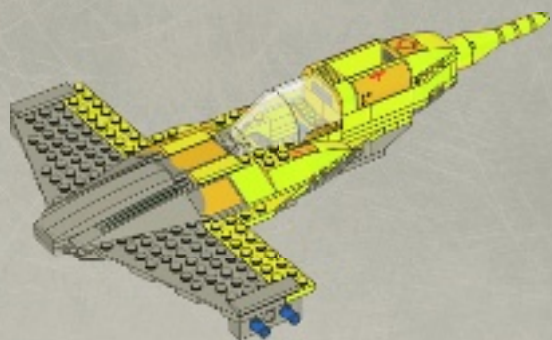
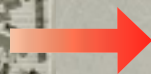

3

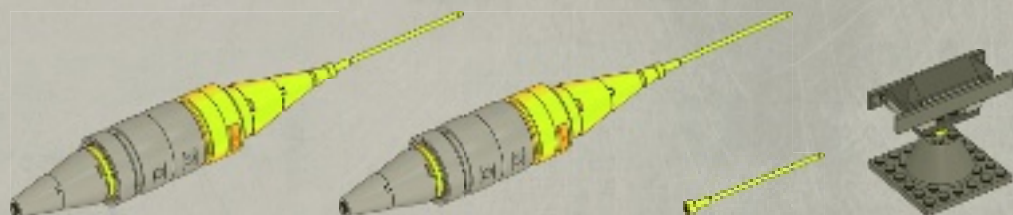
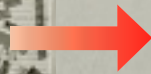

AVERTISSEMENT : RISQUE D'ÉTOUFFEMENT.
Le jouet contient des petites pièces ainsi qu'une petite boule.
Il ne convient pas aux enfants de moins de 3 ans.



ADVERTENCIA: PELIGRO DE ASFIXIA.
Juguete que contiene partes pequeñas y una pelota pequeña.
No recomendado para niños menores de 3 años.

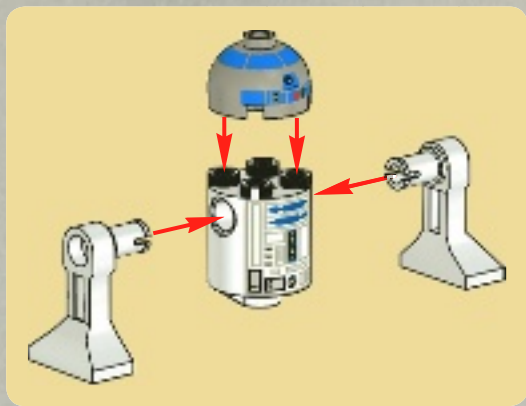
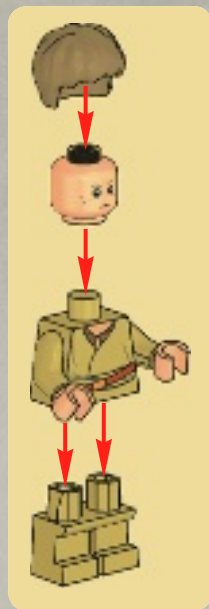
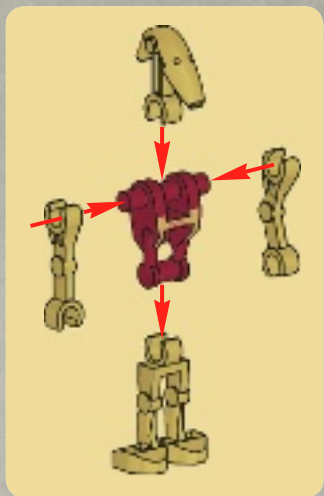

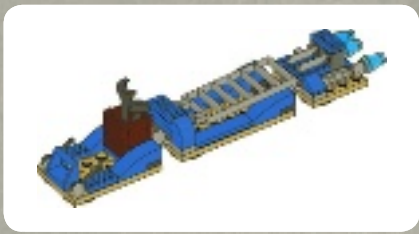

1

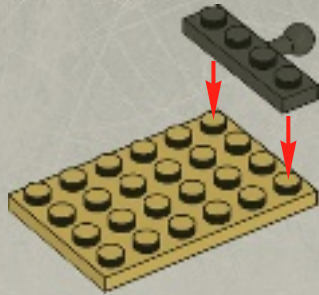

2

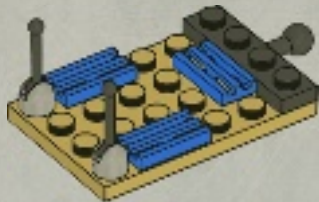

3

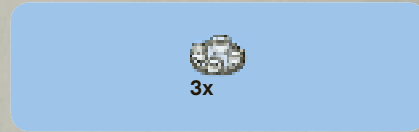
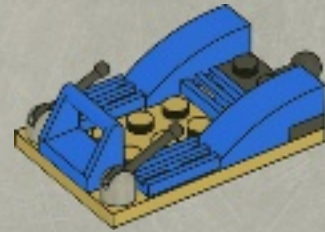

4



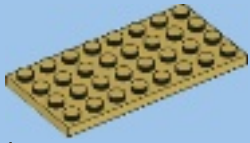

1x



1x

1

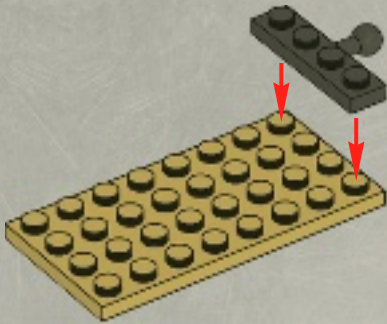

2x



1x

2

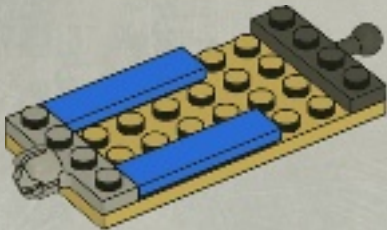

1x



2x



1x

3

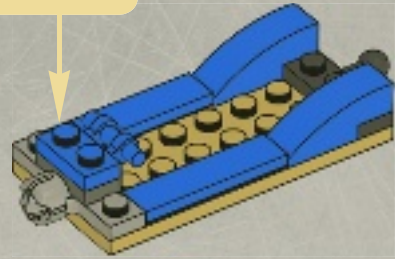
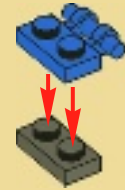

2x

4

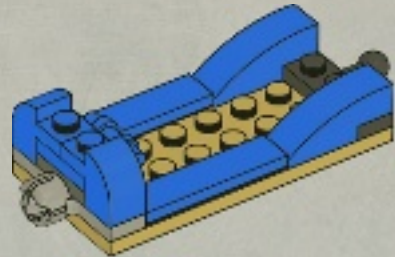

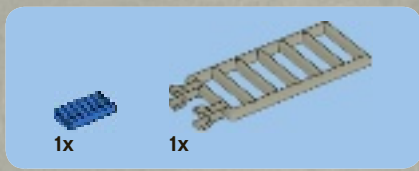

5

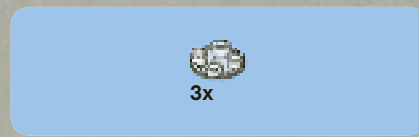
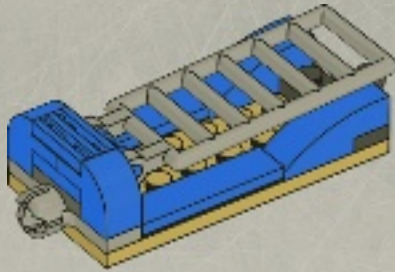

6

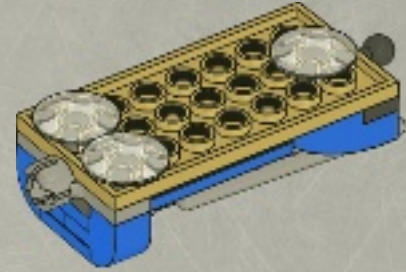

7

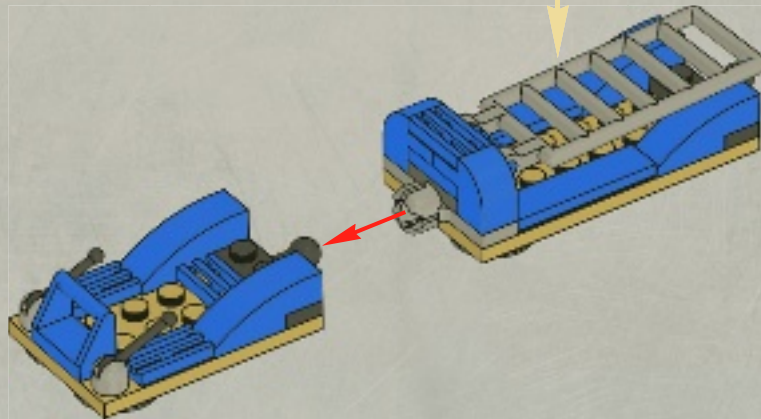



1x

1

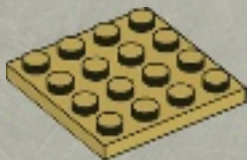

1x



1x



2x

2

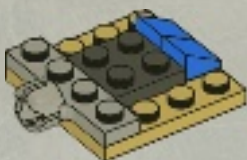

1x



2x

3

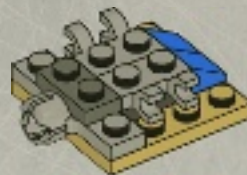

3x

4





1x



2x

5

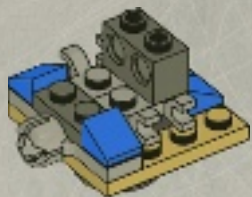

3x

6

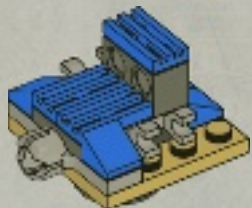

4x



4x

7

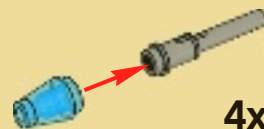

4x

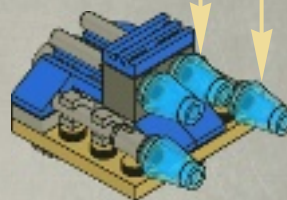

8

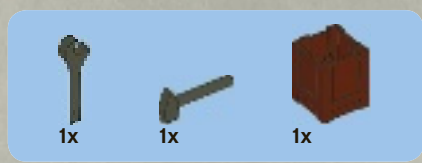
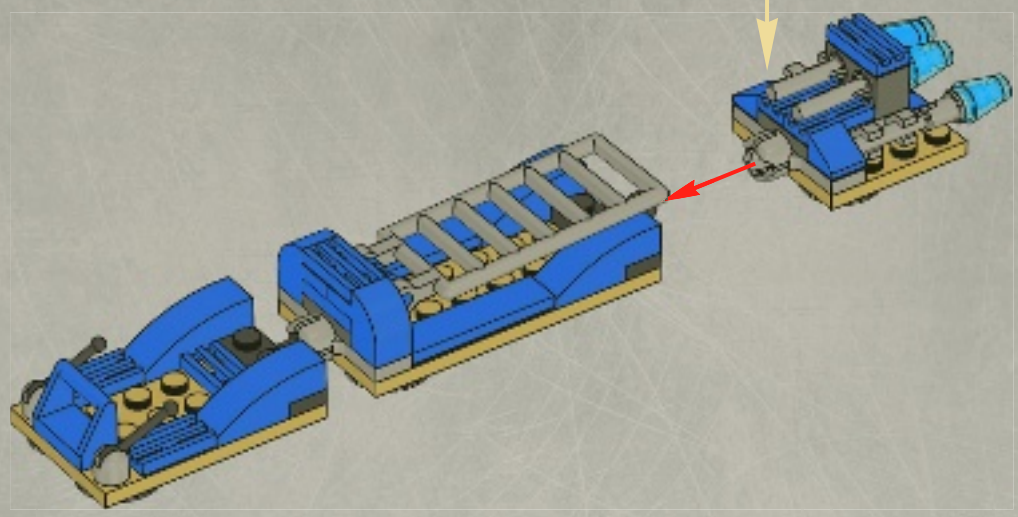

9

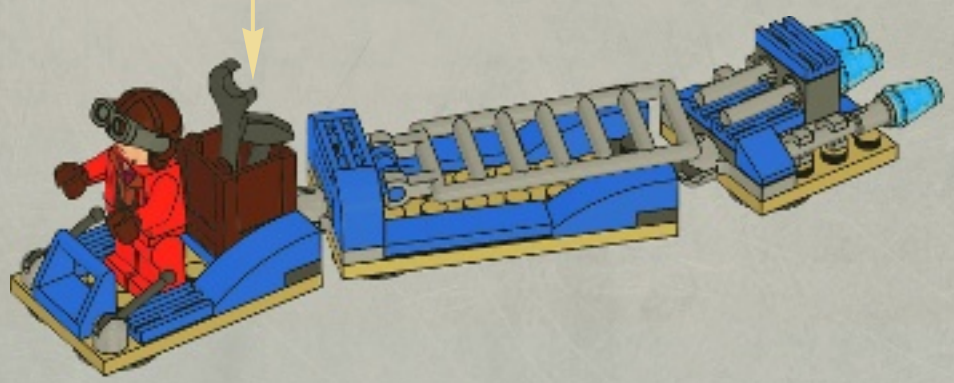

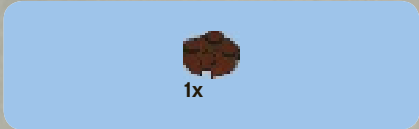

1



2

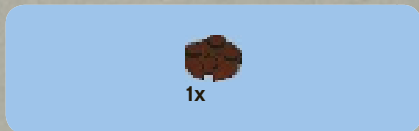

3

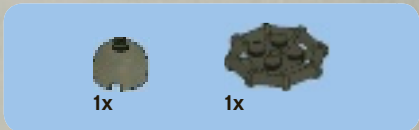

4



3x



3x

5

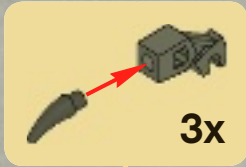

6



2x



3x



2x



6x



7

1



2

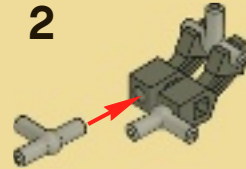

3

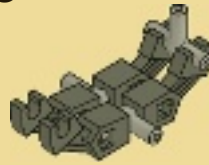

4

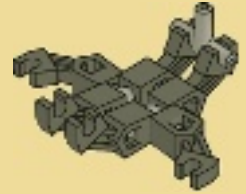

5

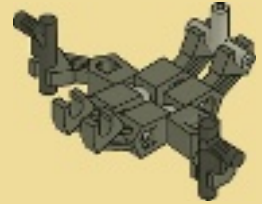

6

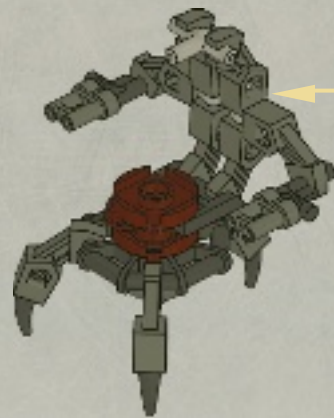
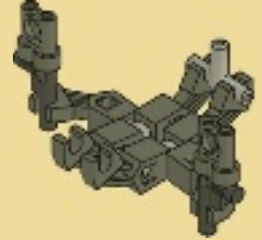

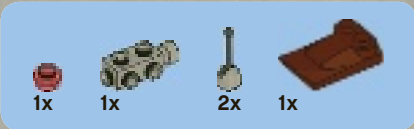

8

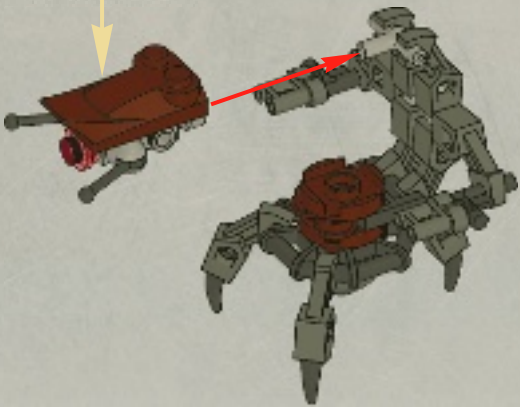

9



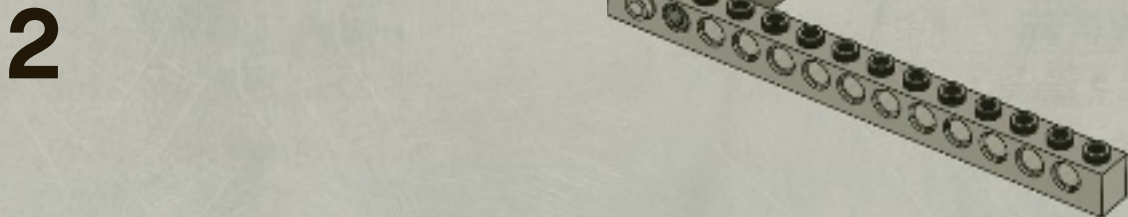
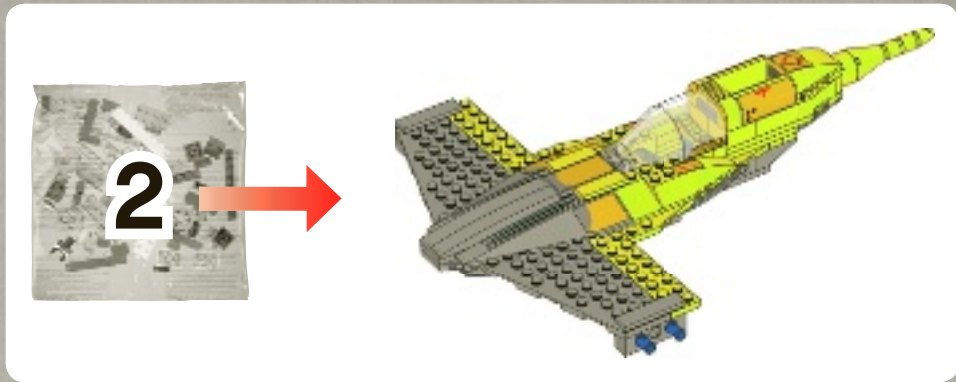



3

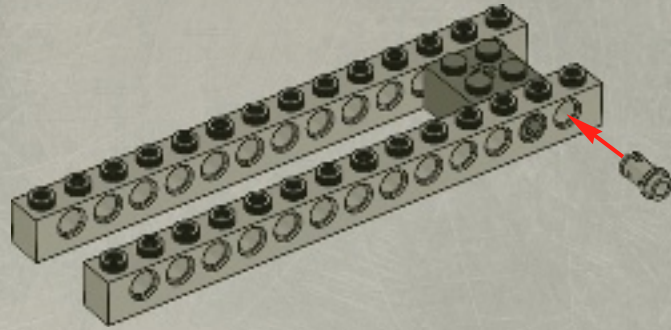

4

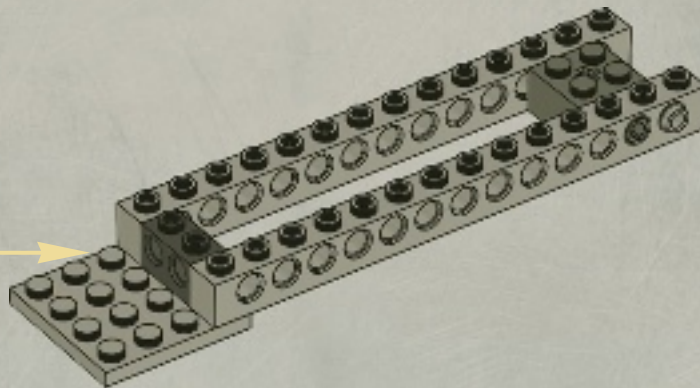
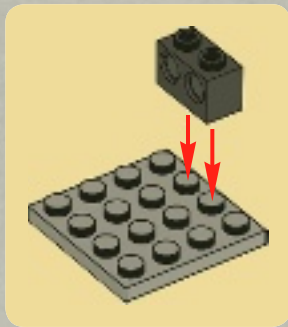



2x

5

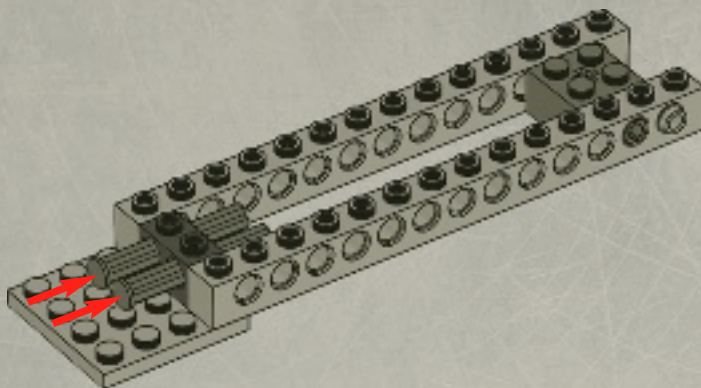

1x



2x

6

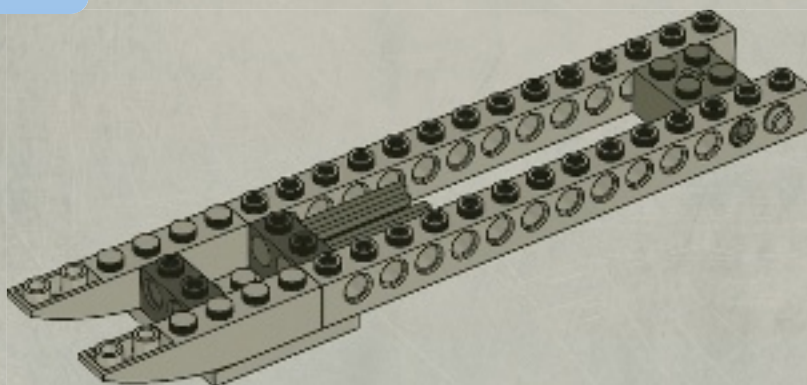

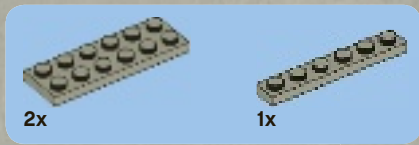

7

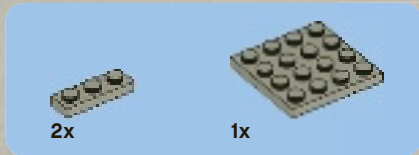
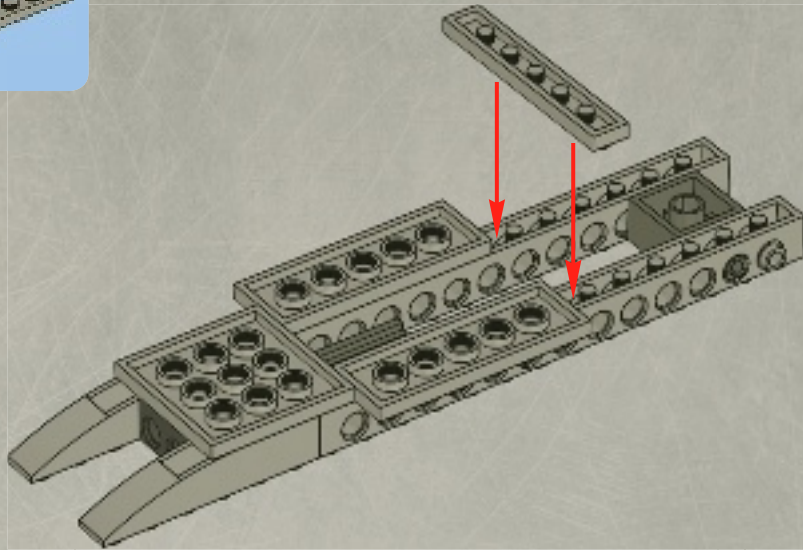

8

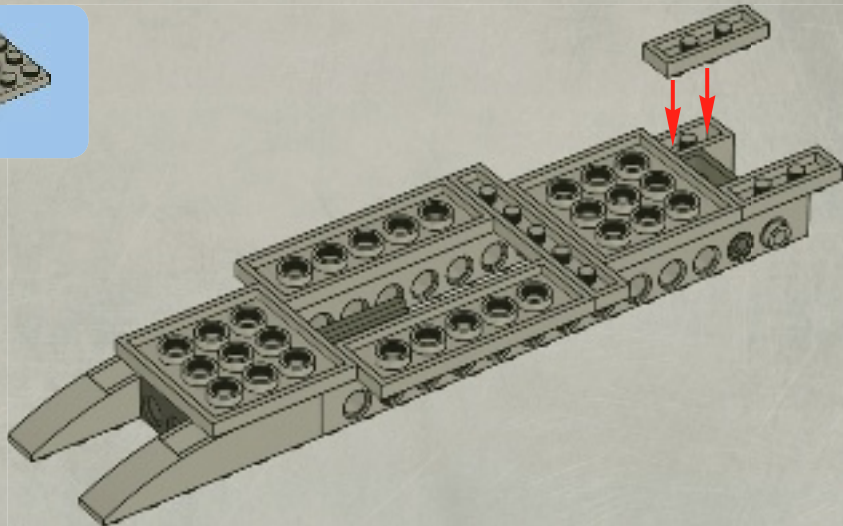



1x



1x

9

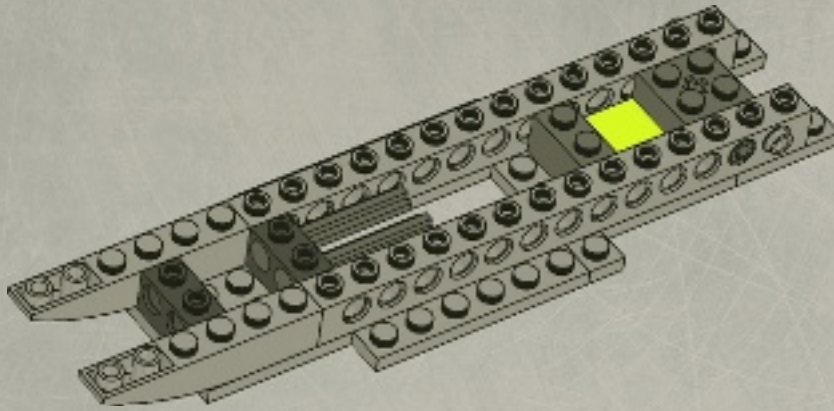

1x



2x

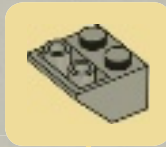

10

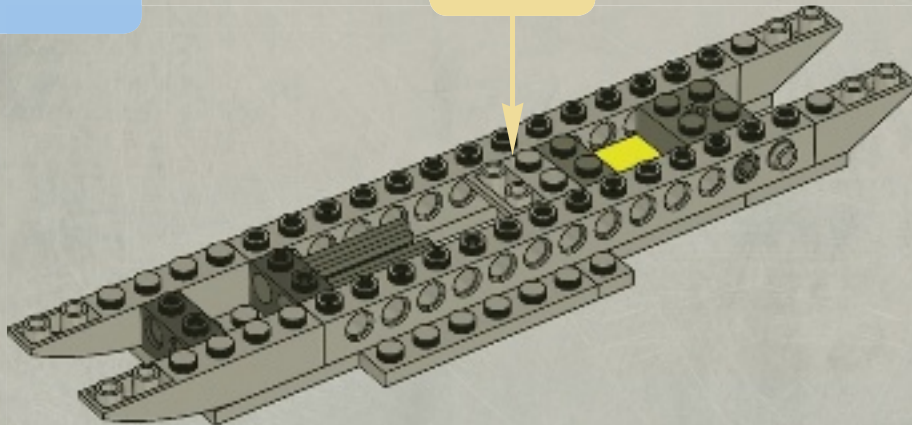



2x



1x

11

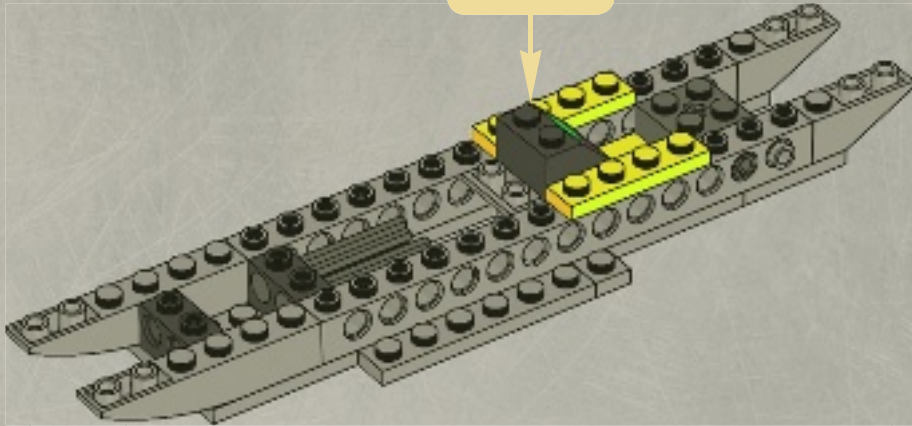

3x

12

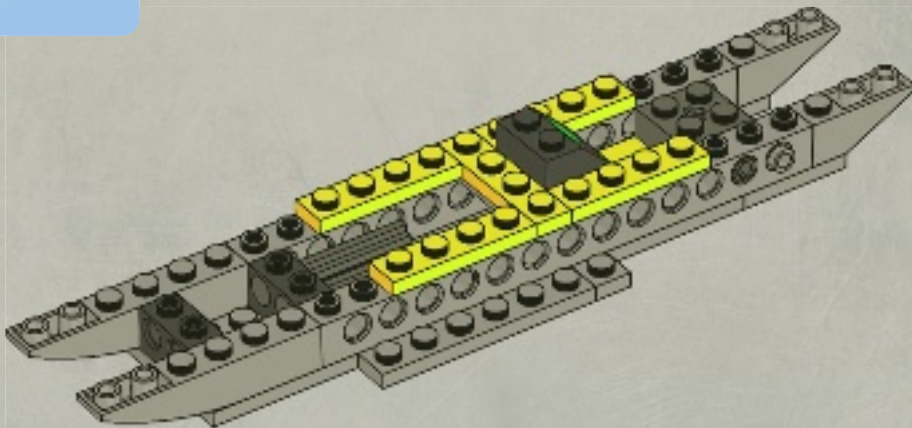

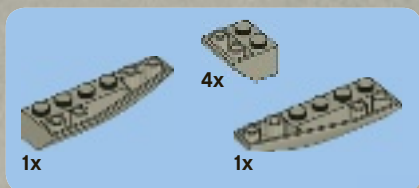

13

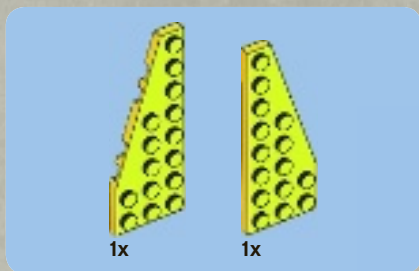
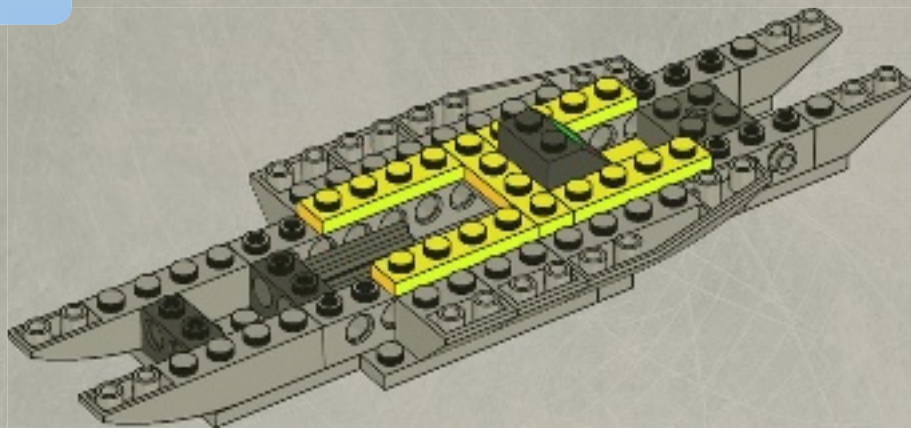

14

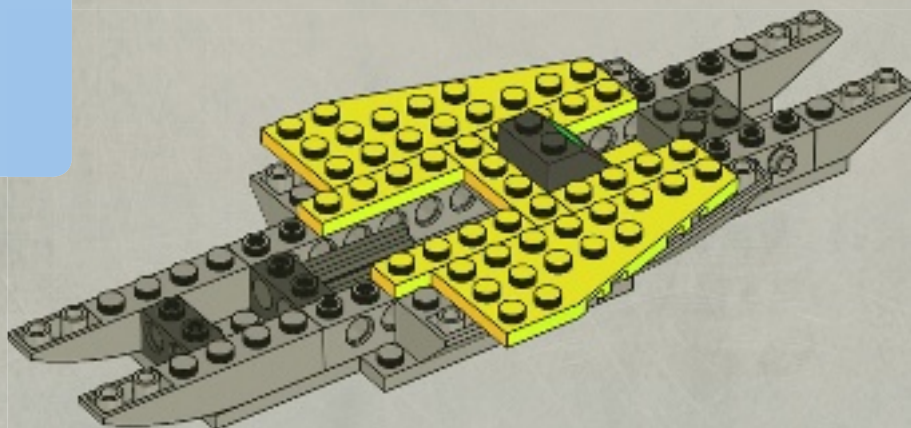



15

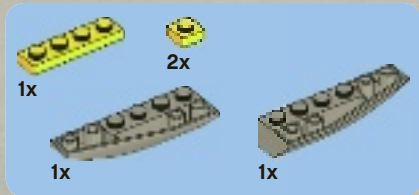
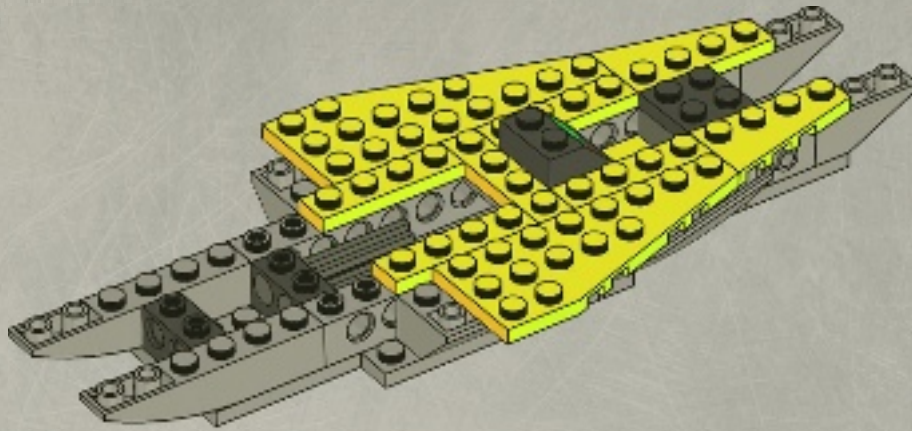

16

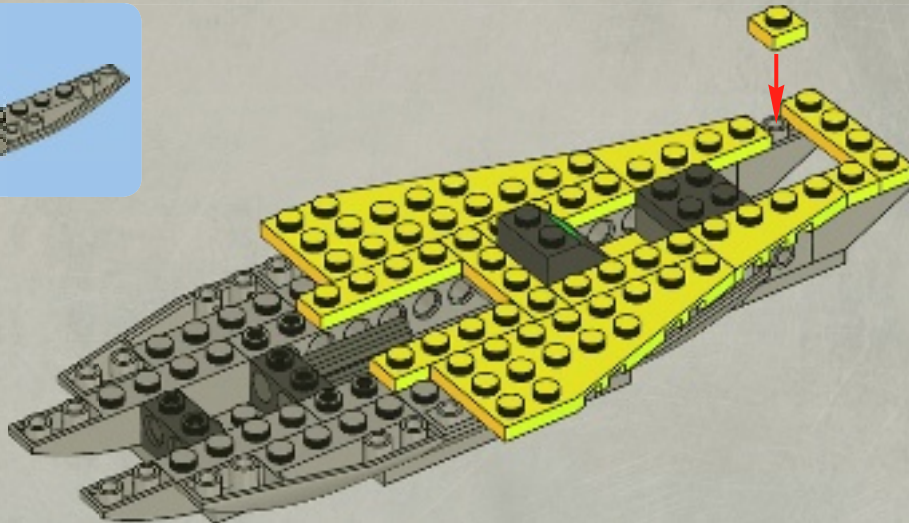

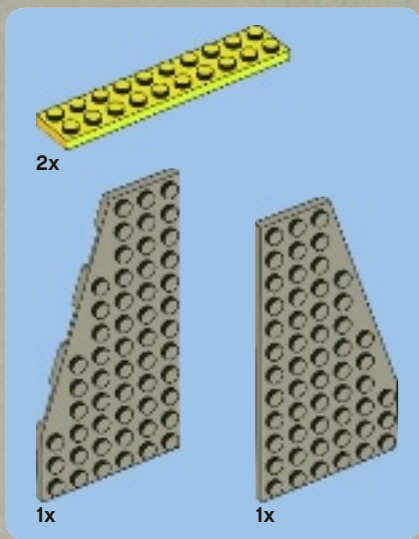

17

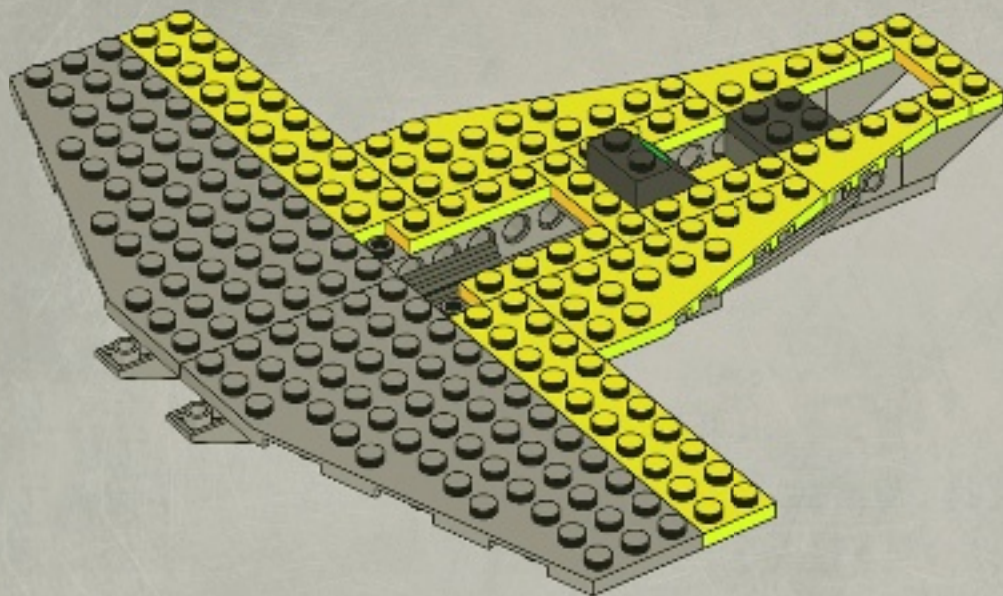



18

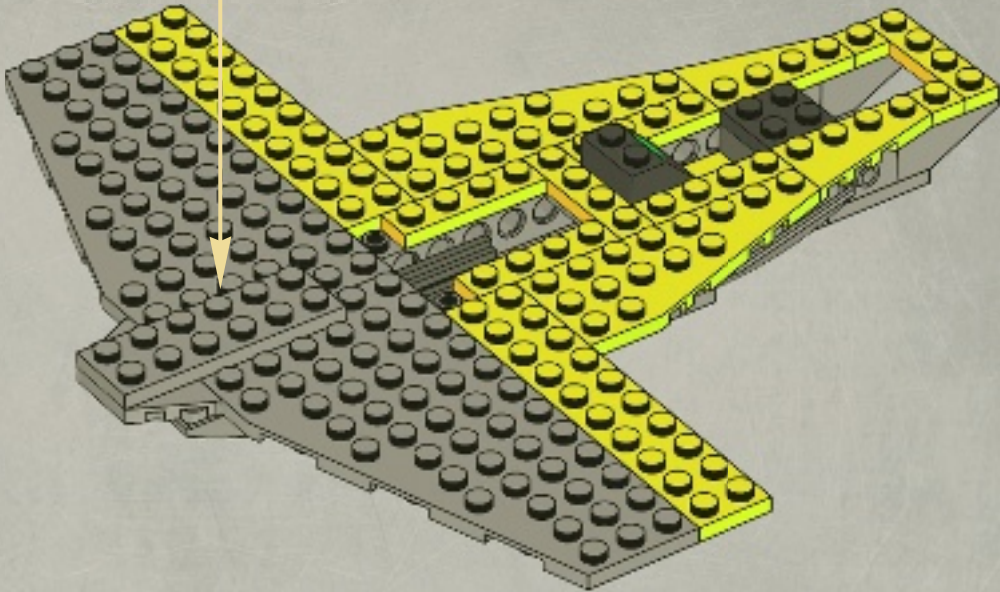
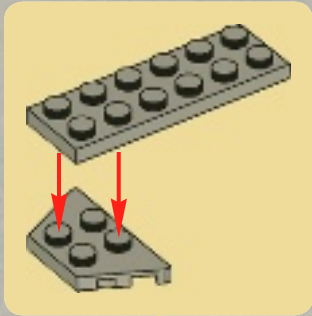



19

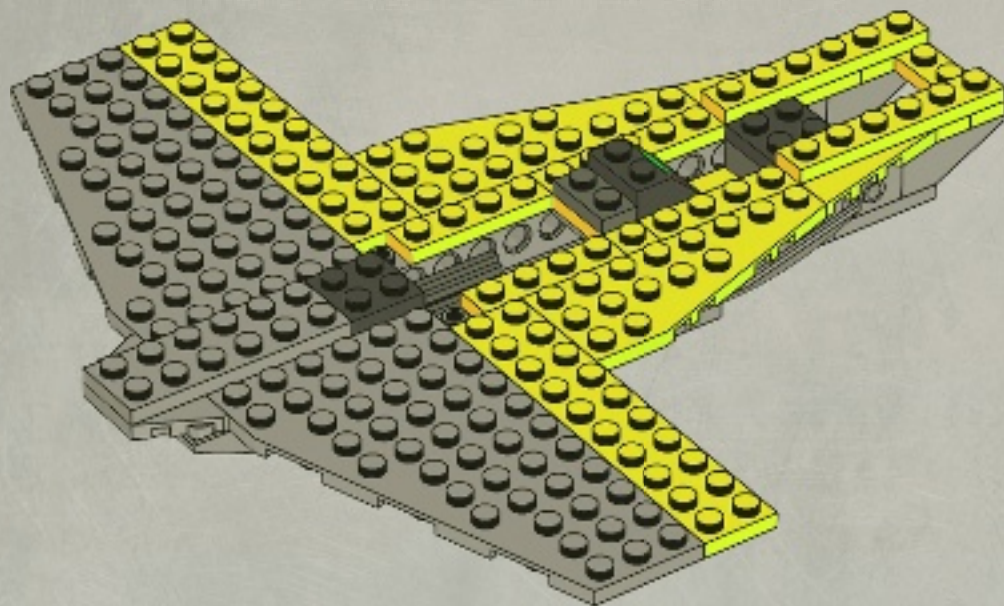



20

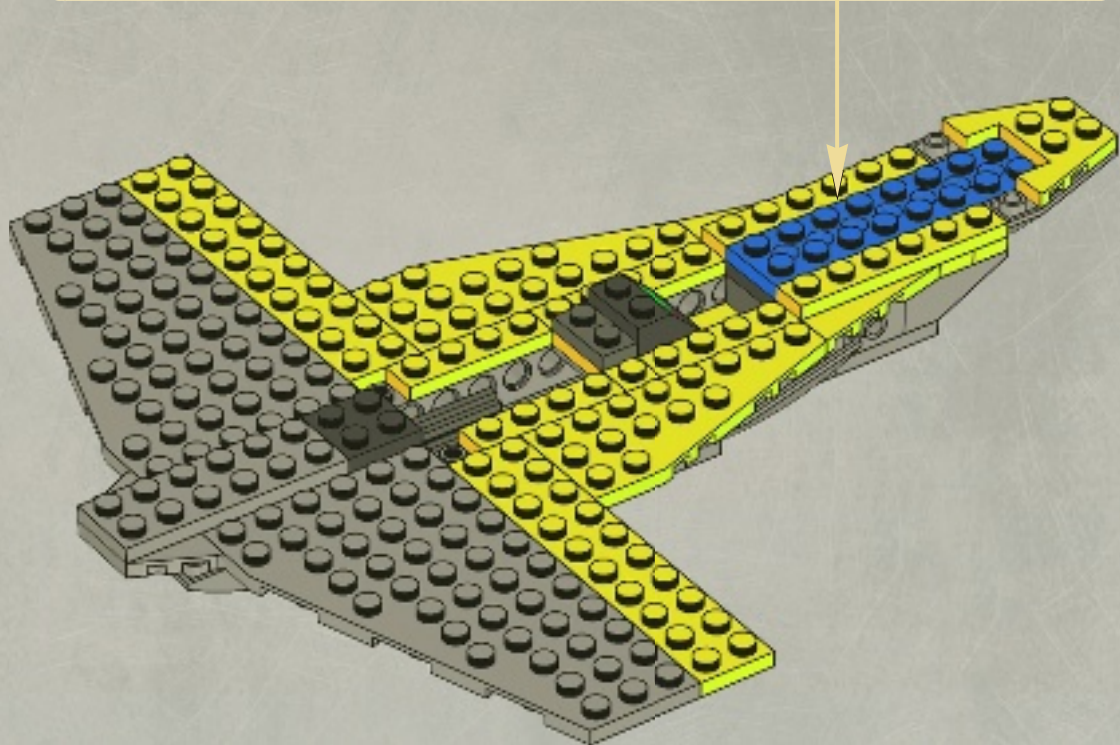
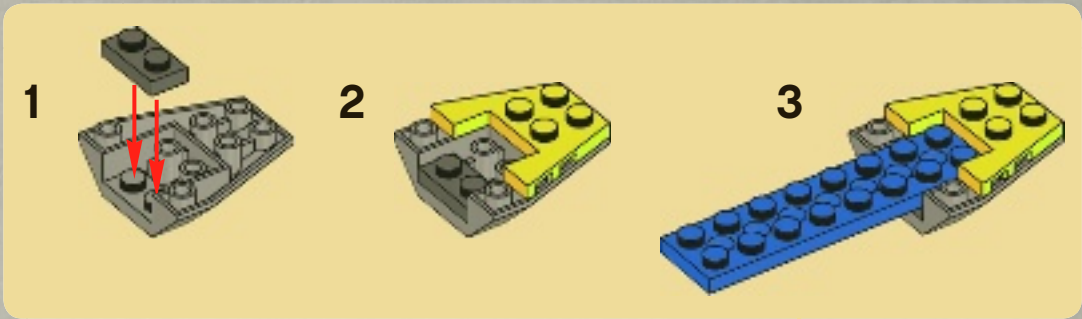



2x

21

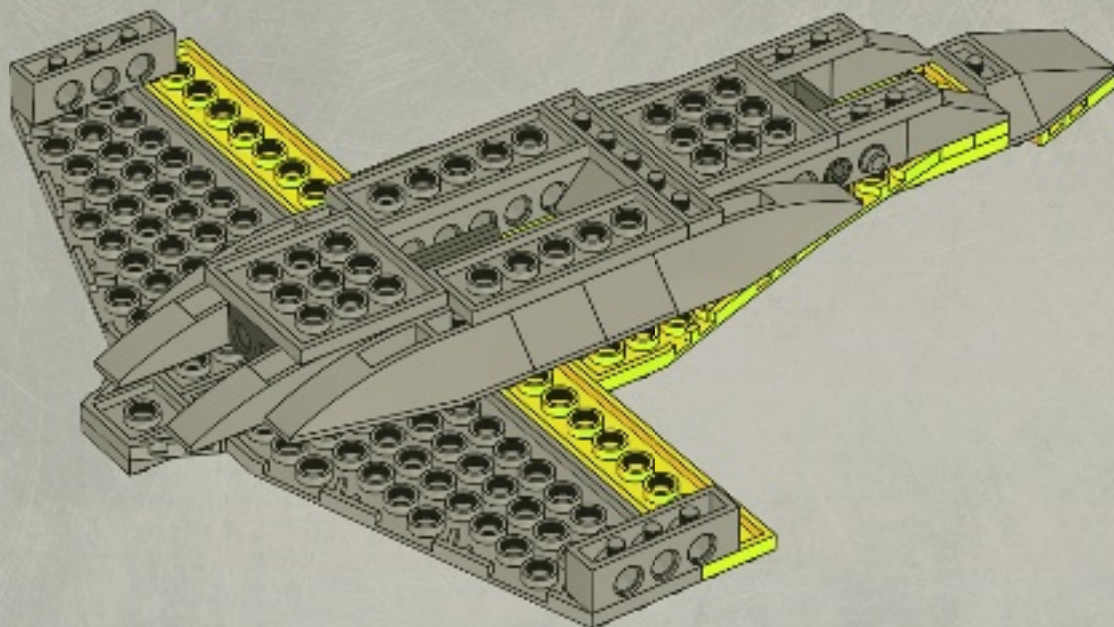



4x

22

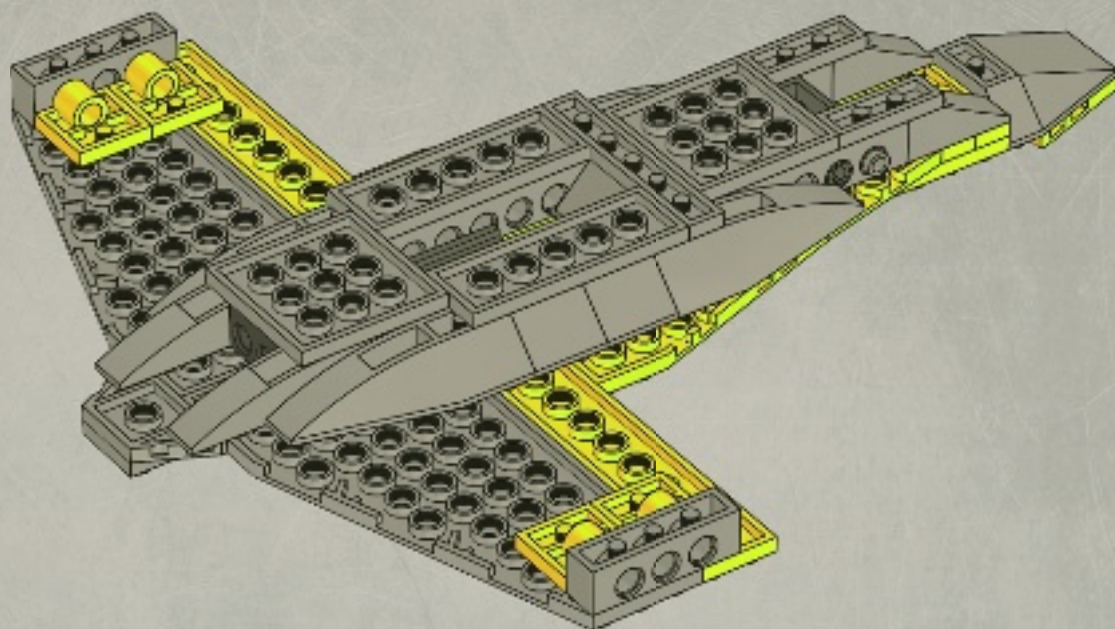

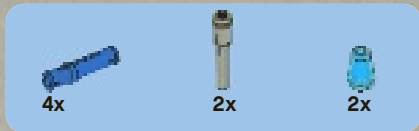

23

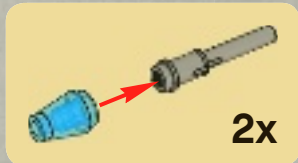
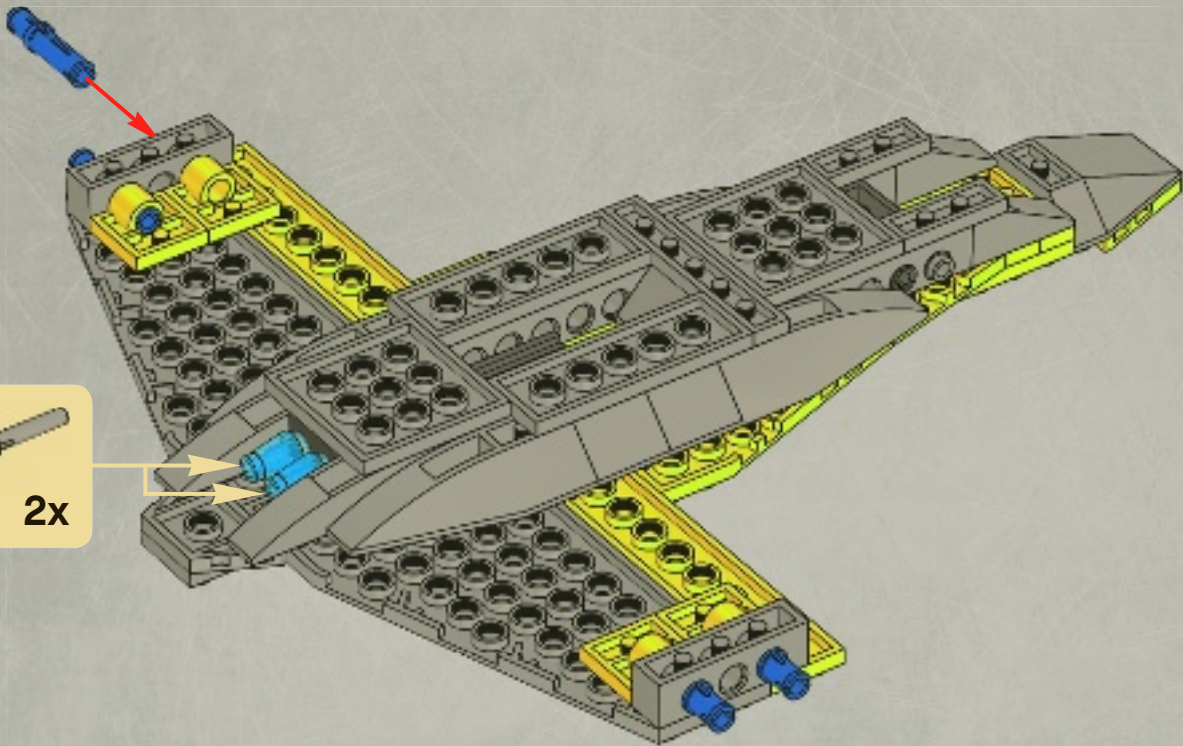

24

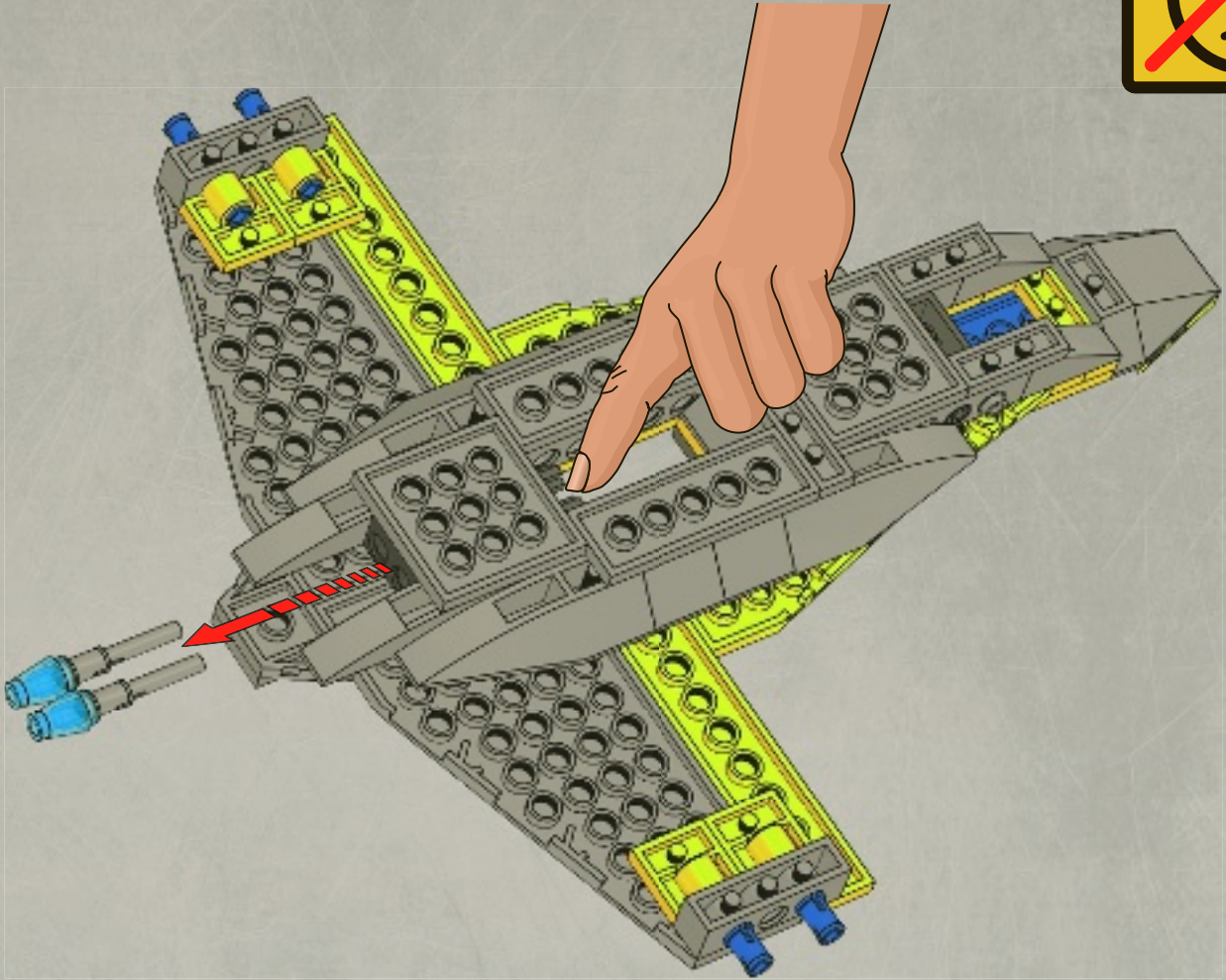

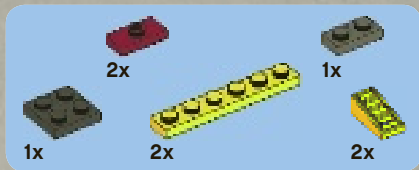

25

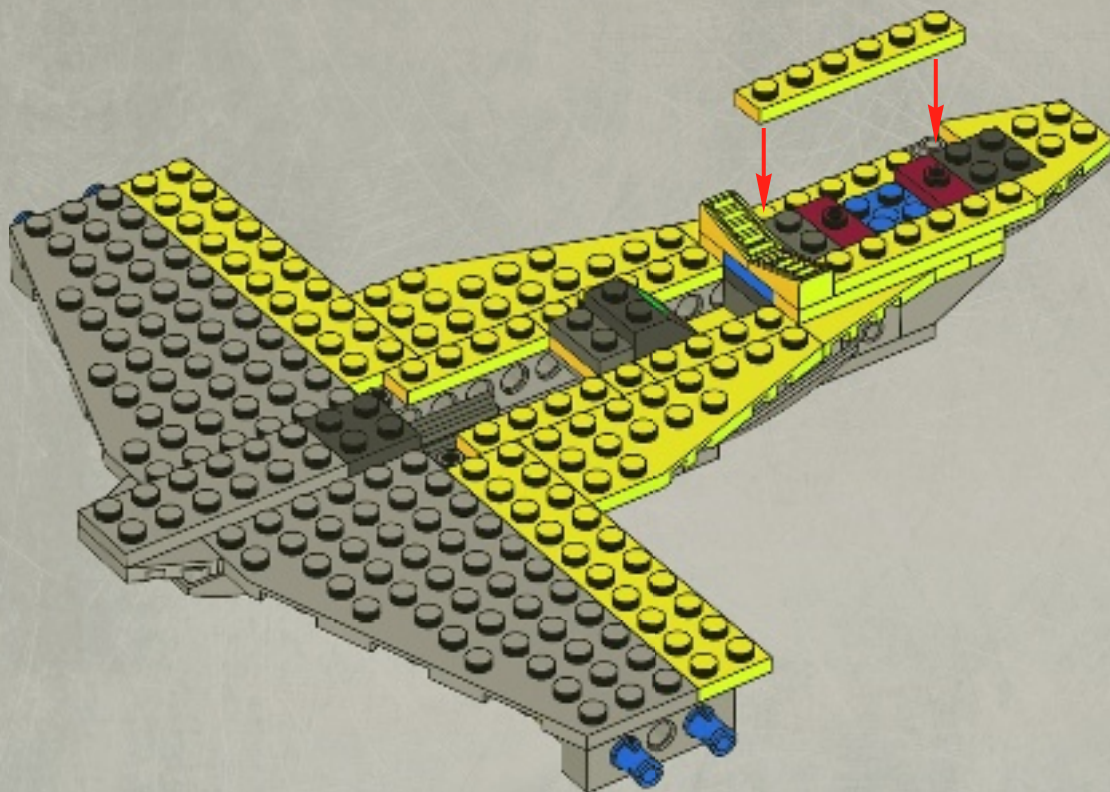



26

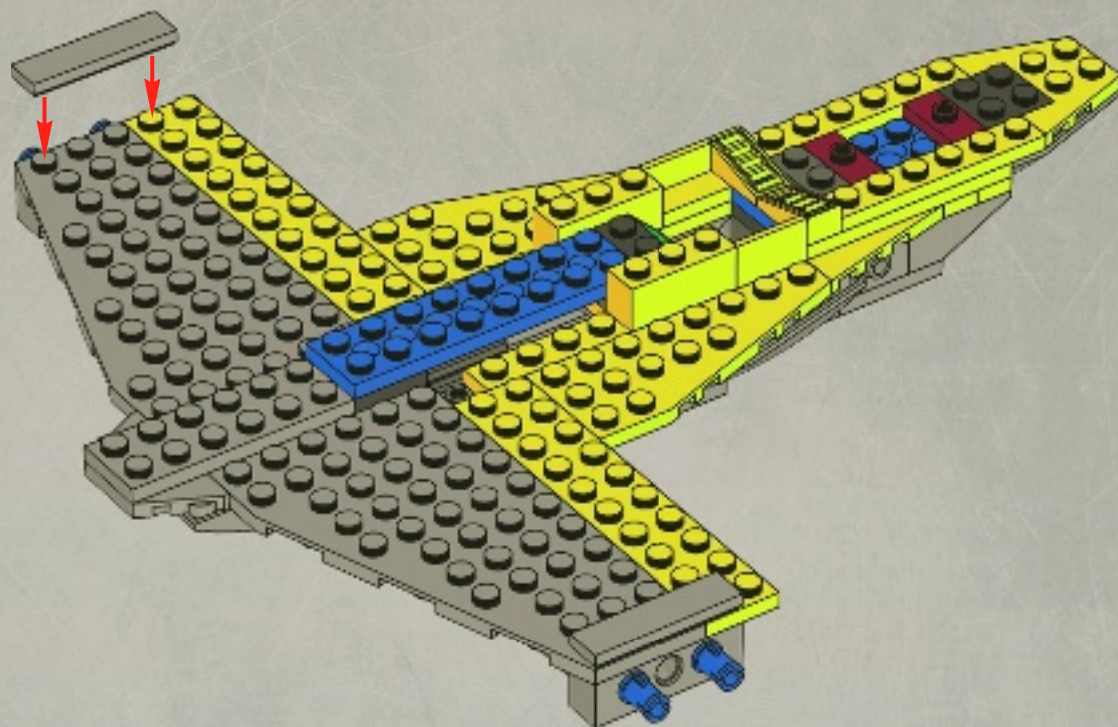

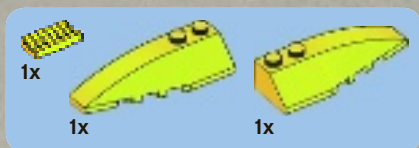

27

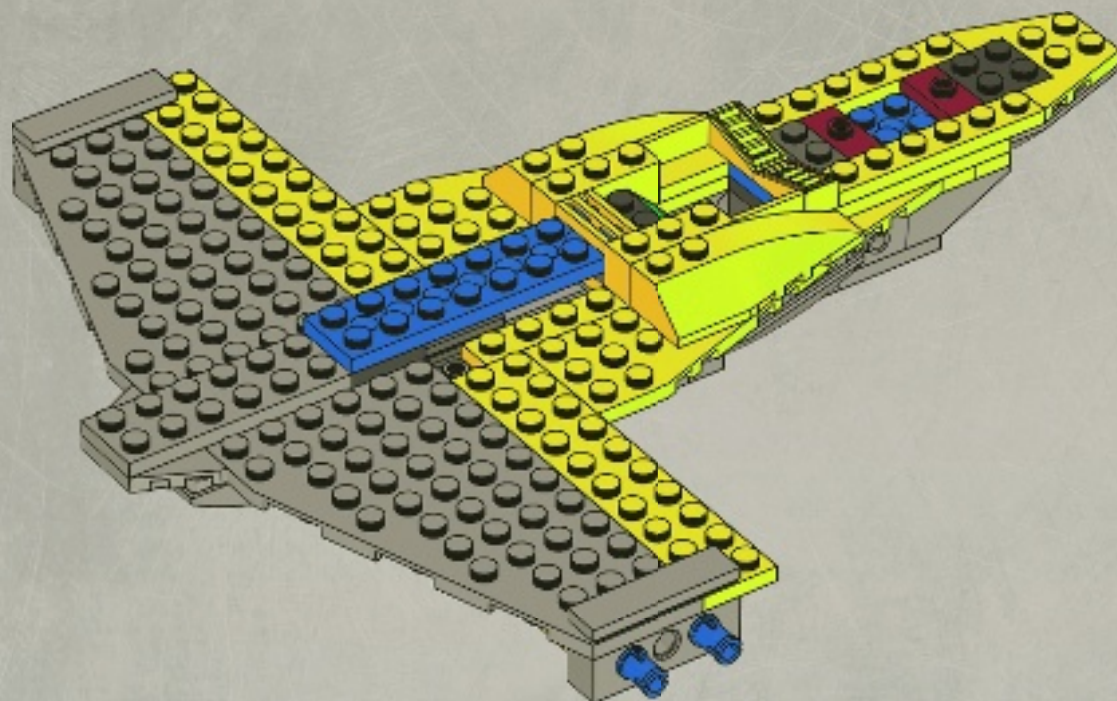

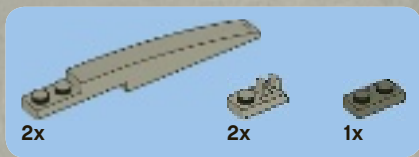

28

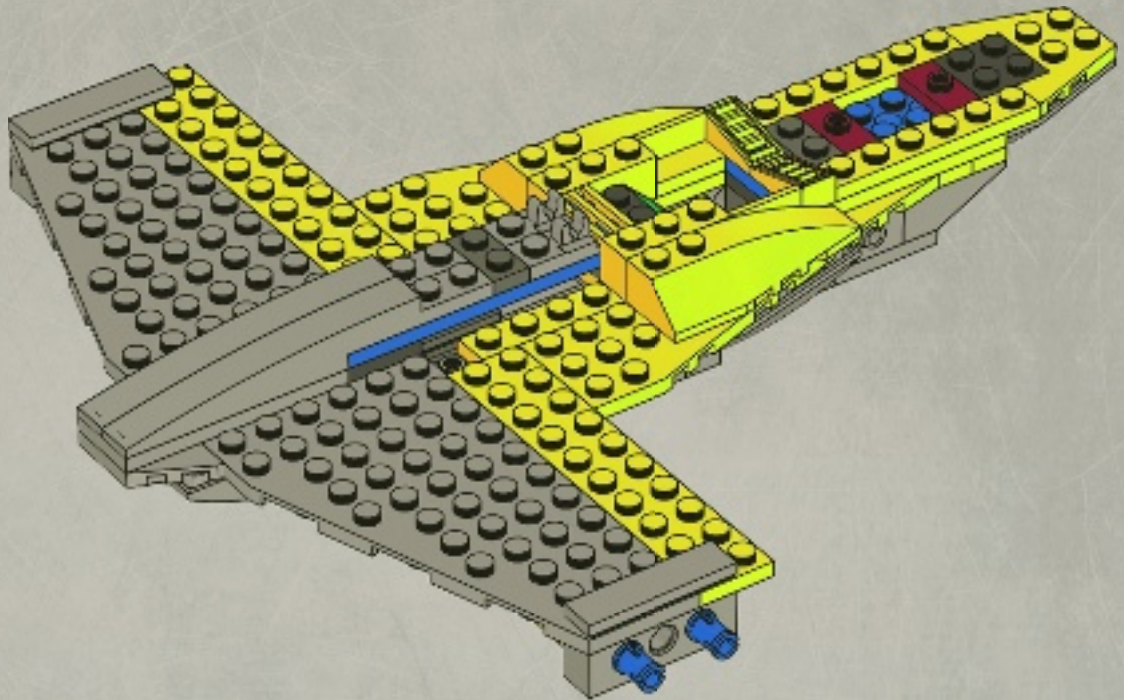



1x



1x



1x

29

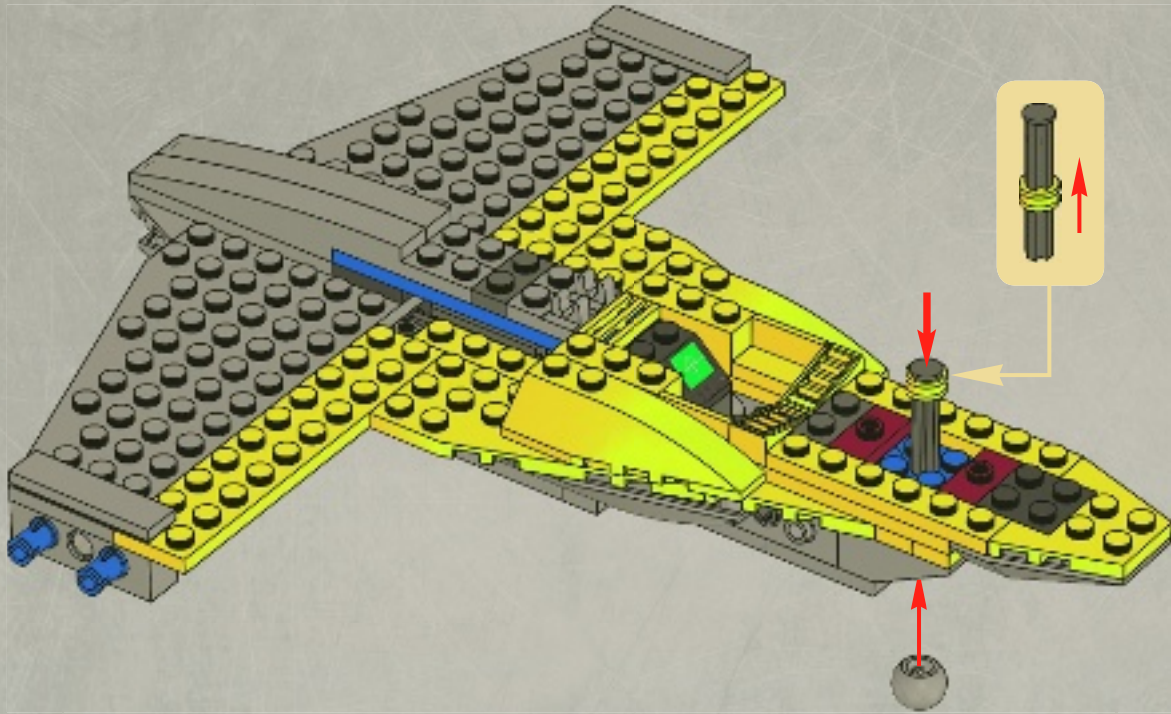

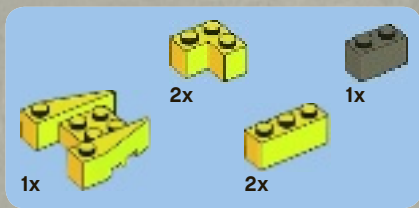

30

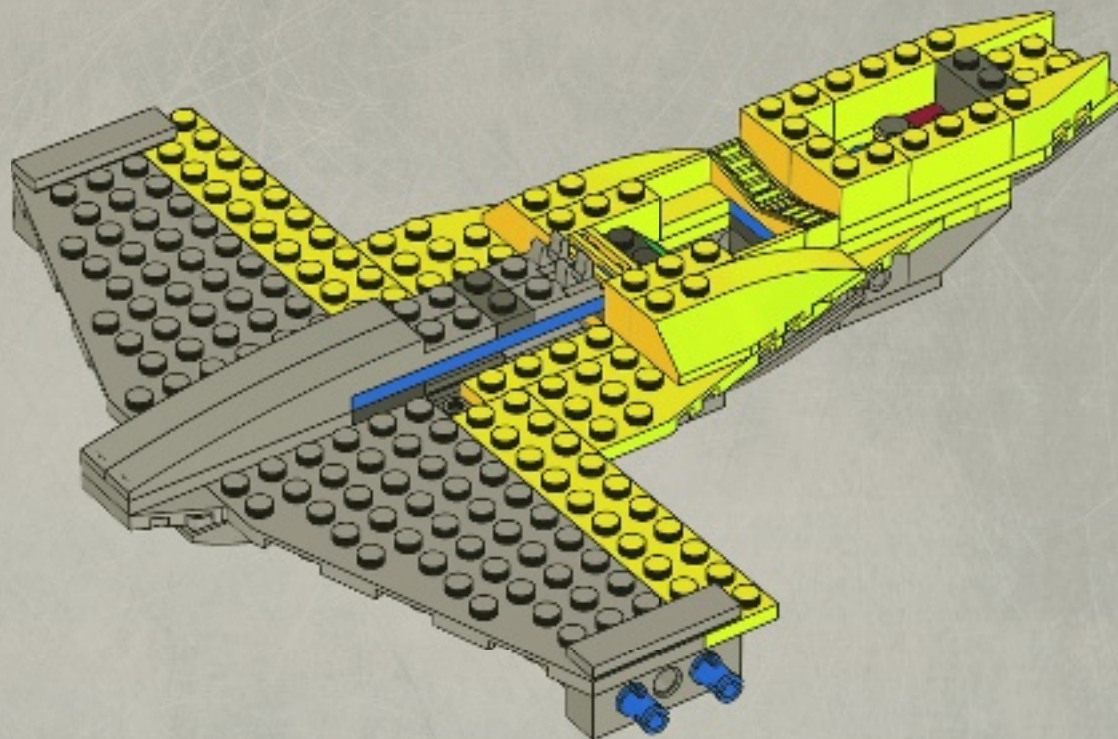

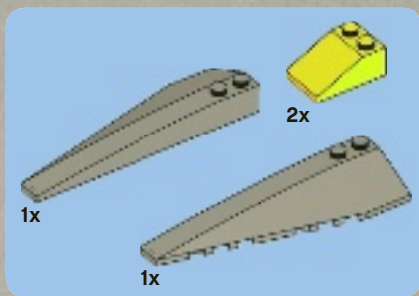

31

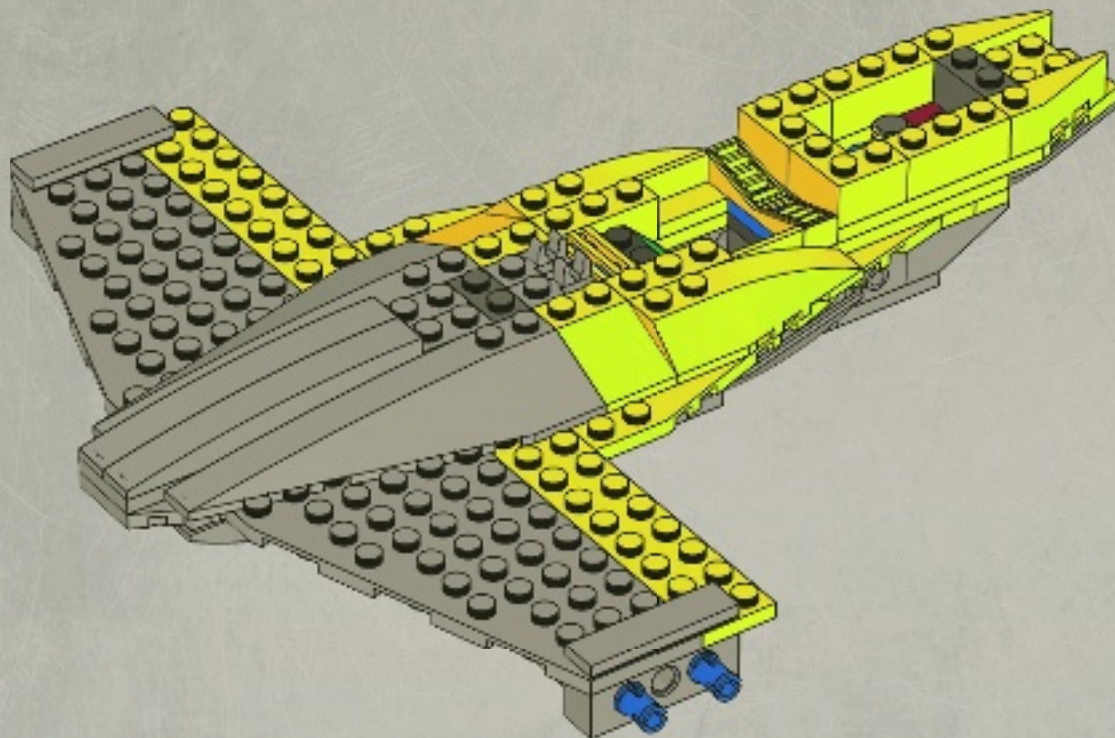



2x



1x

32

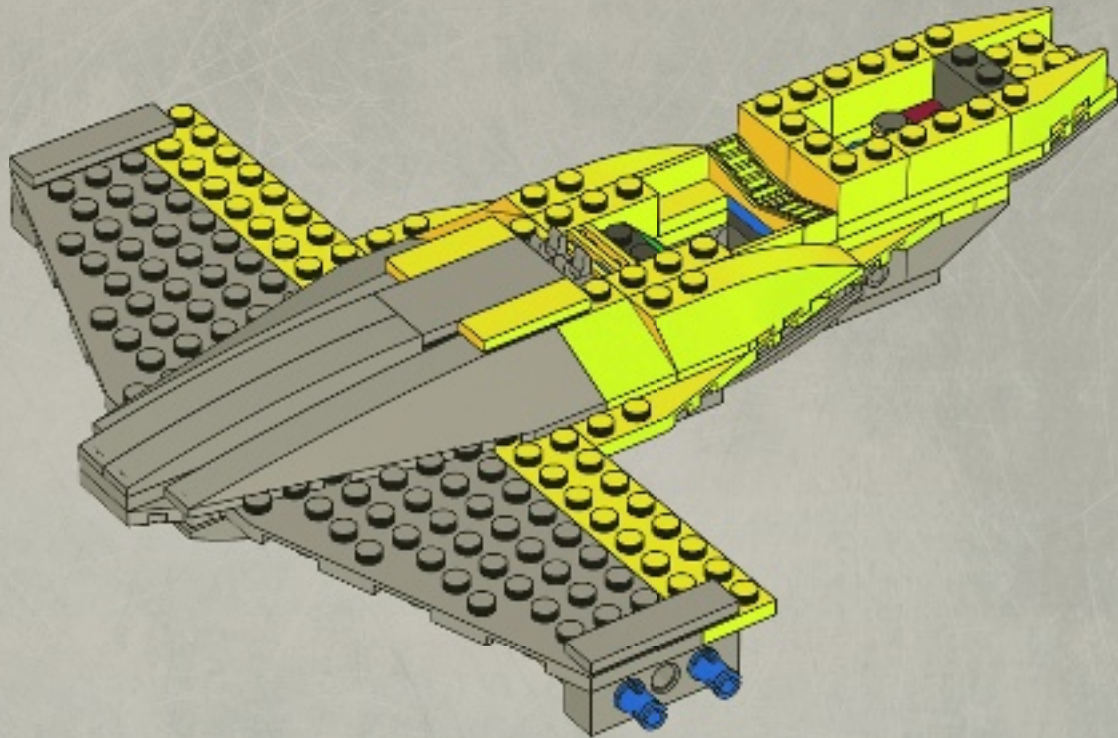



33

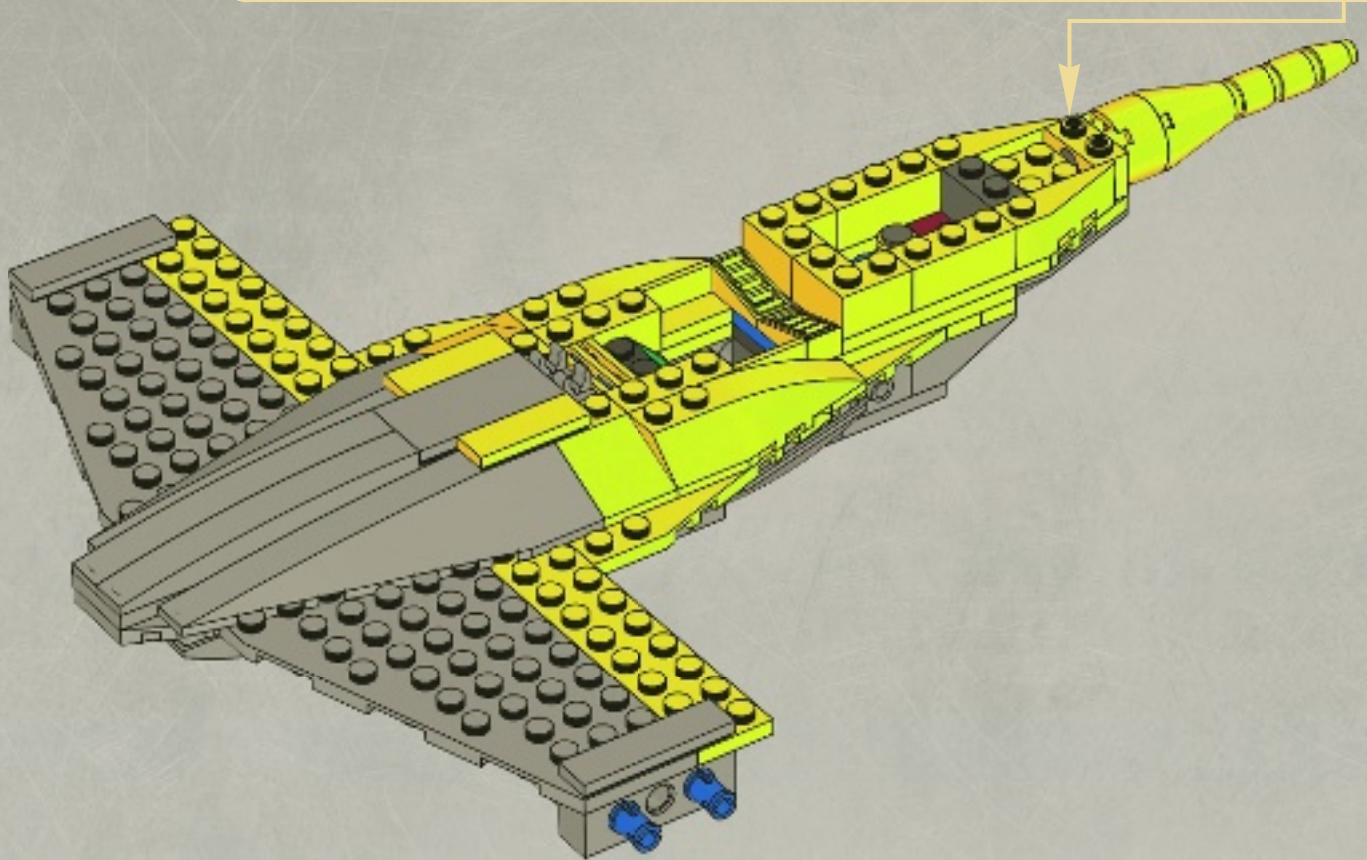
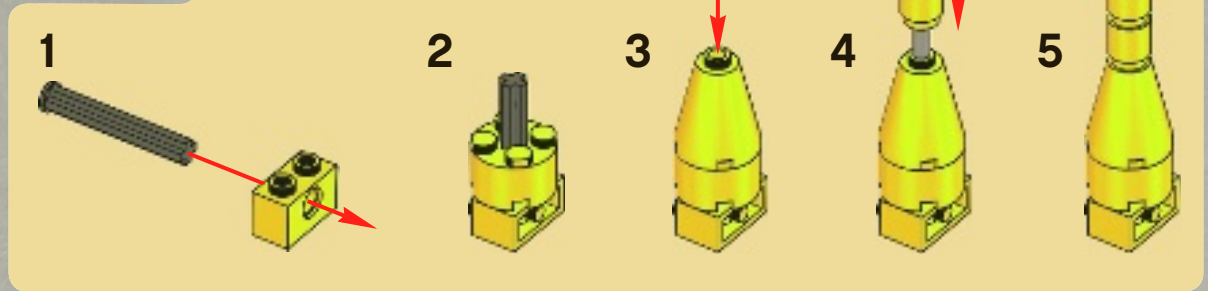



1x



1x

34

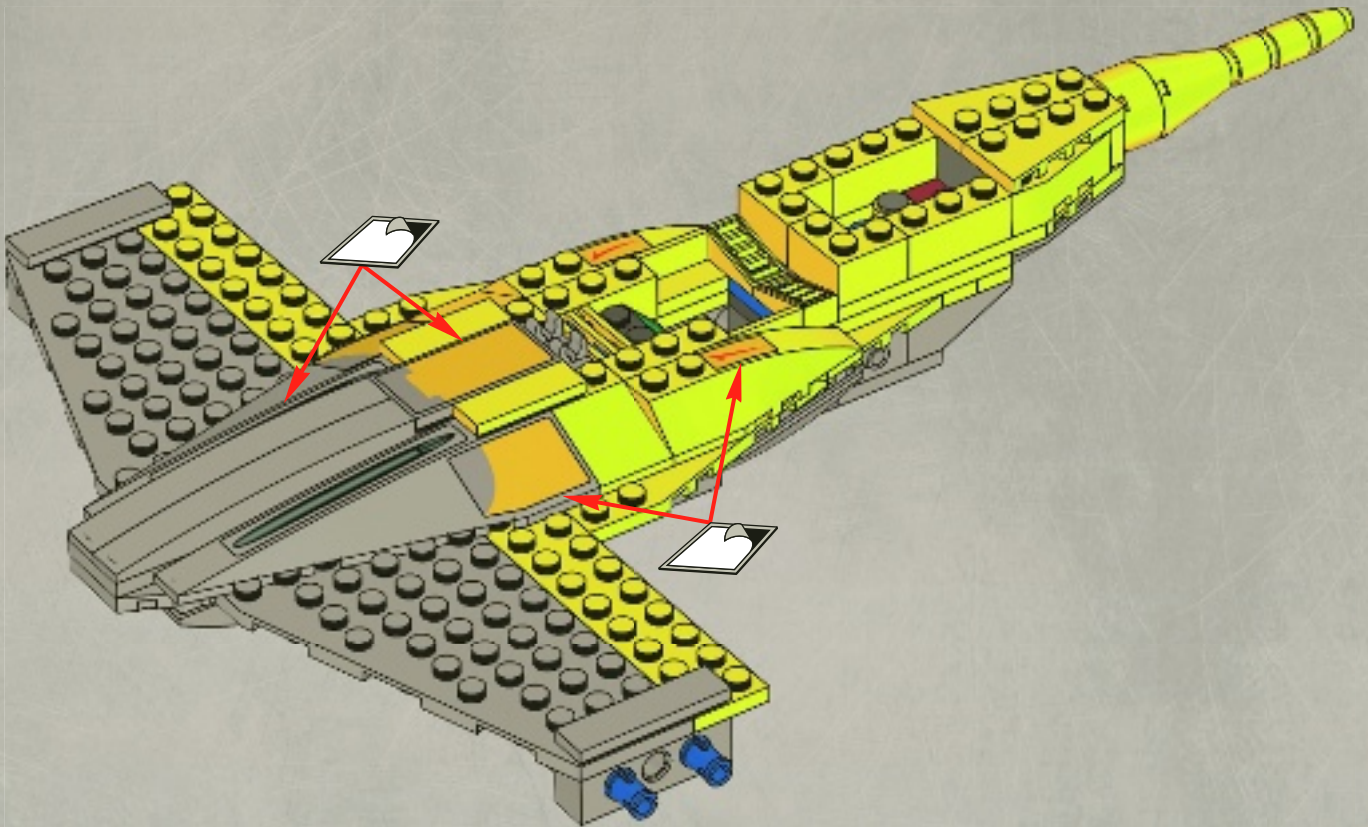



4x

35

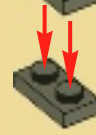

2x

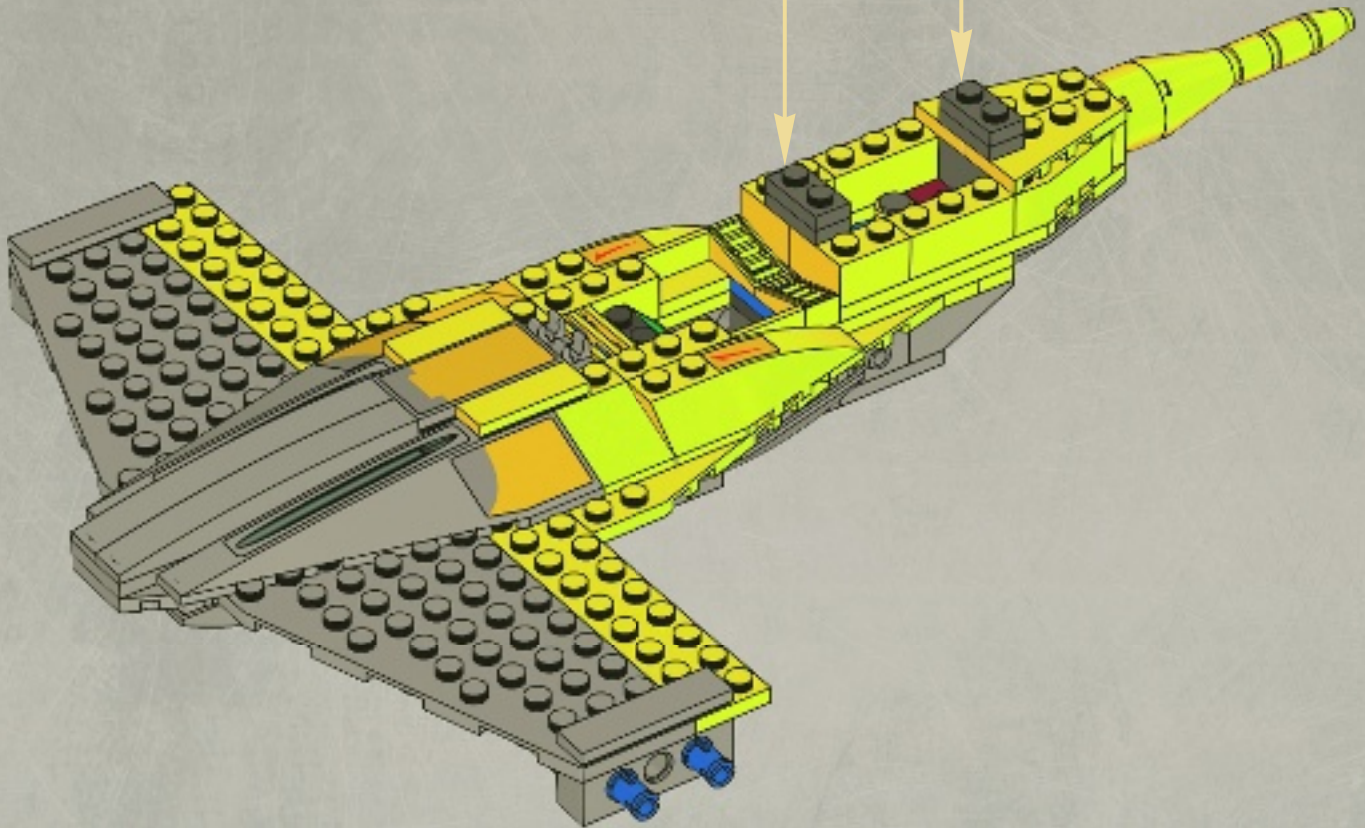

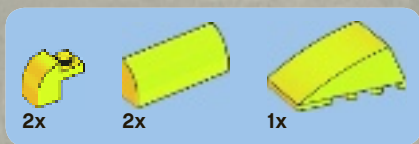

36

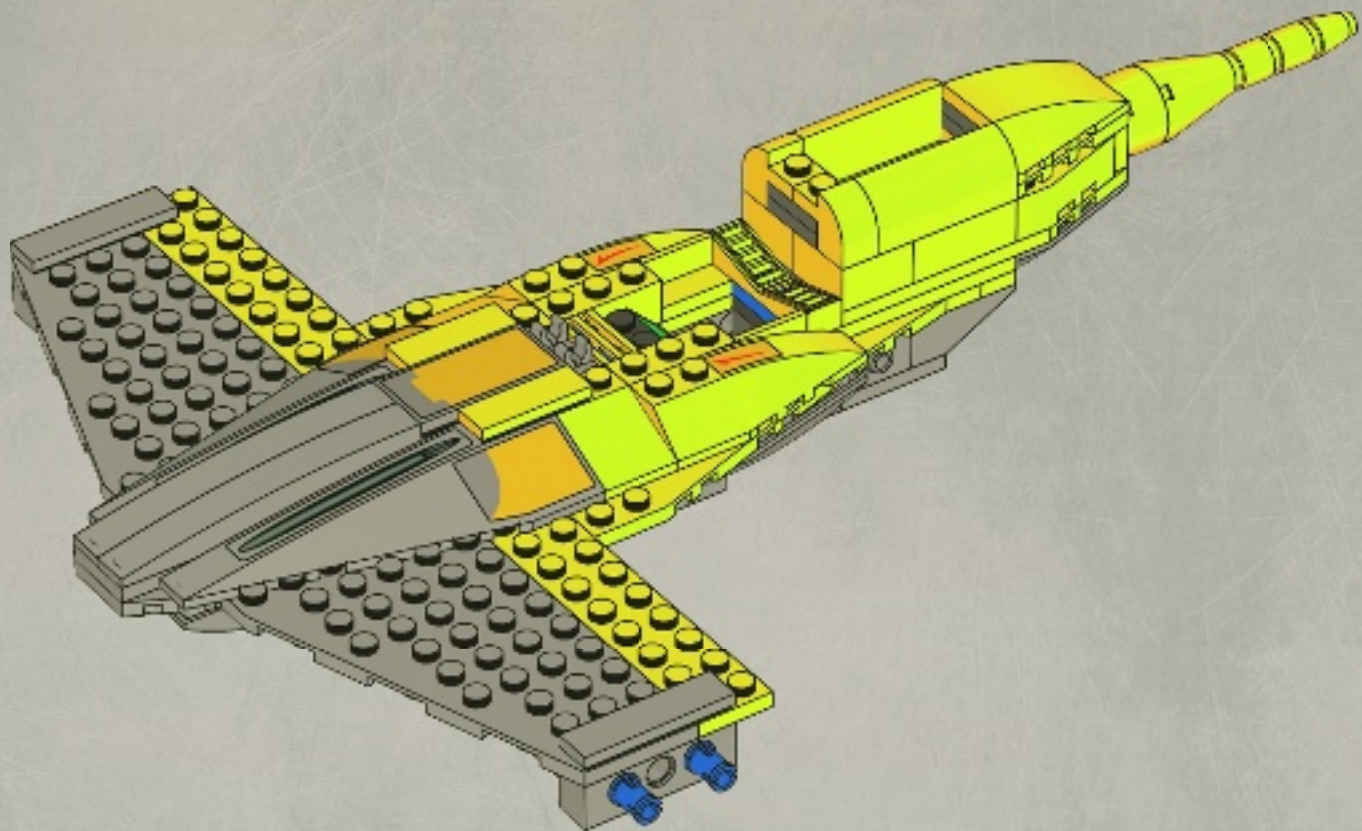



1x

37

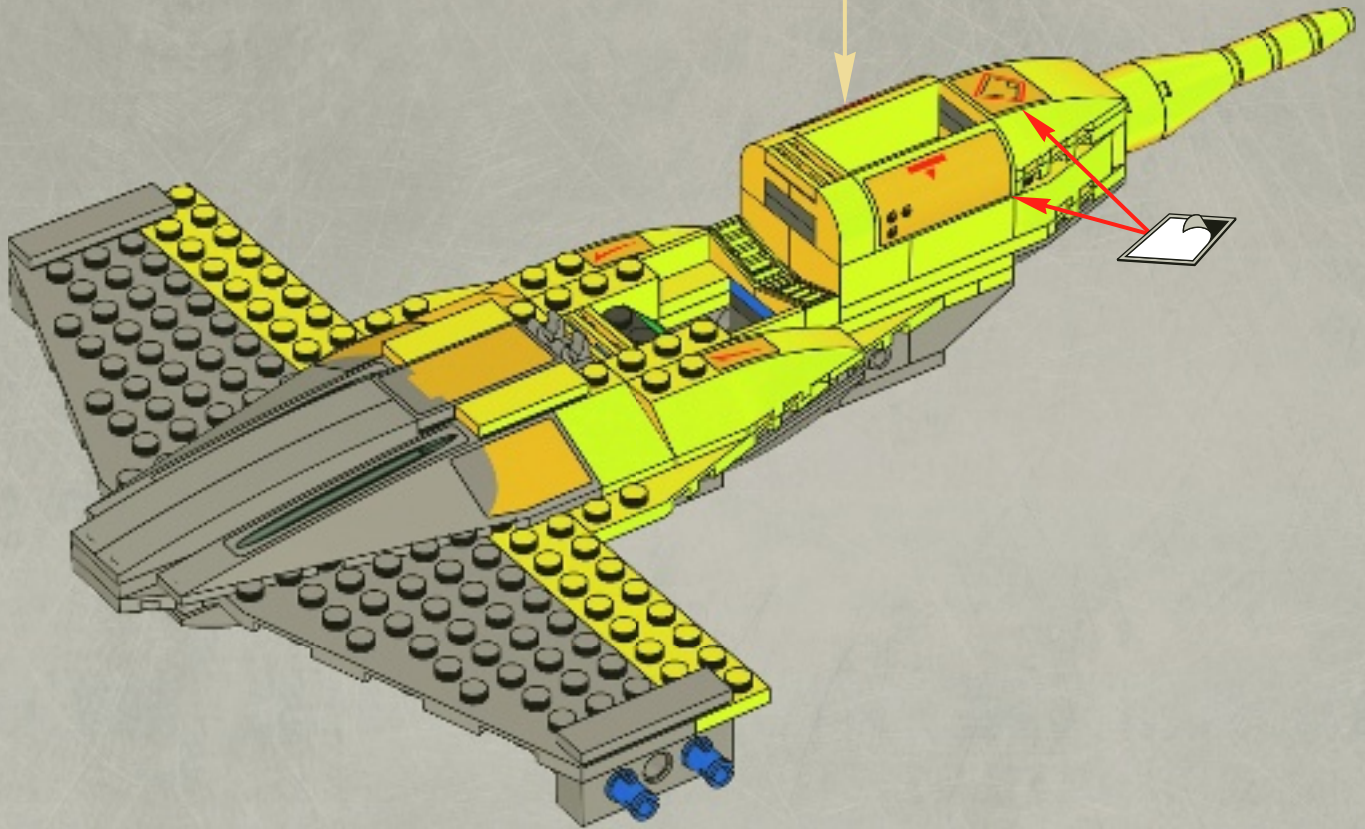

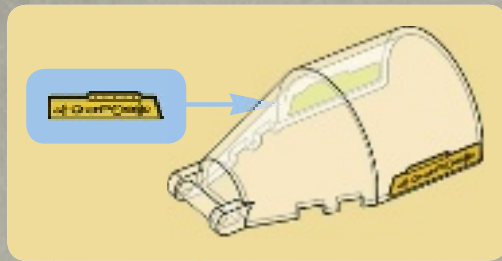
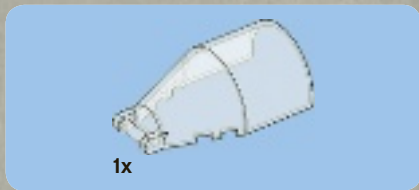

38

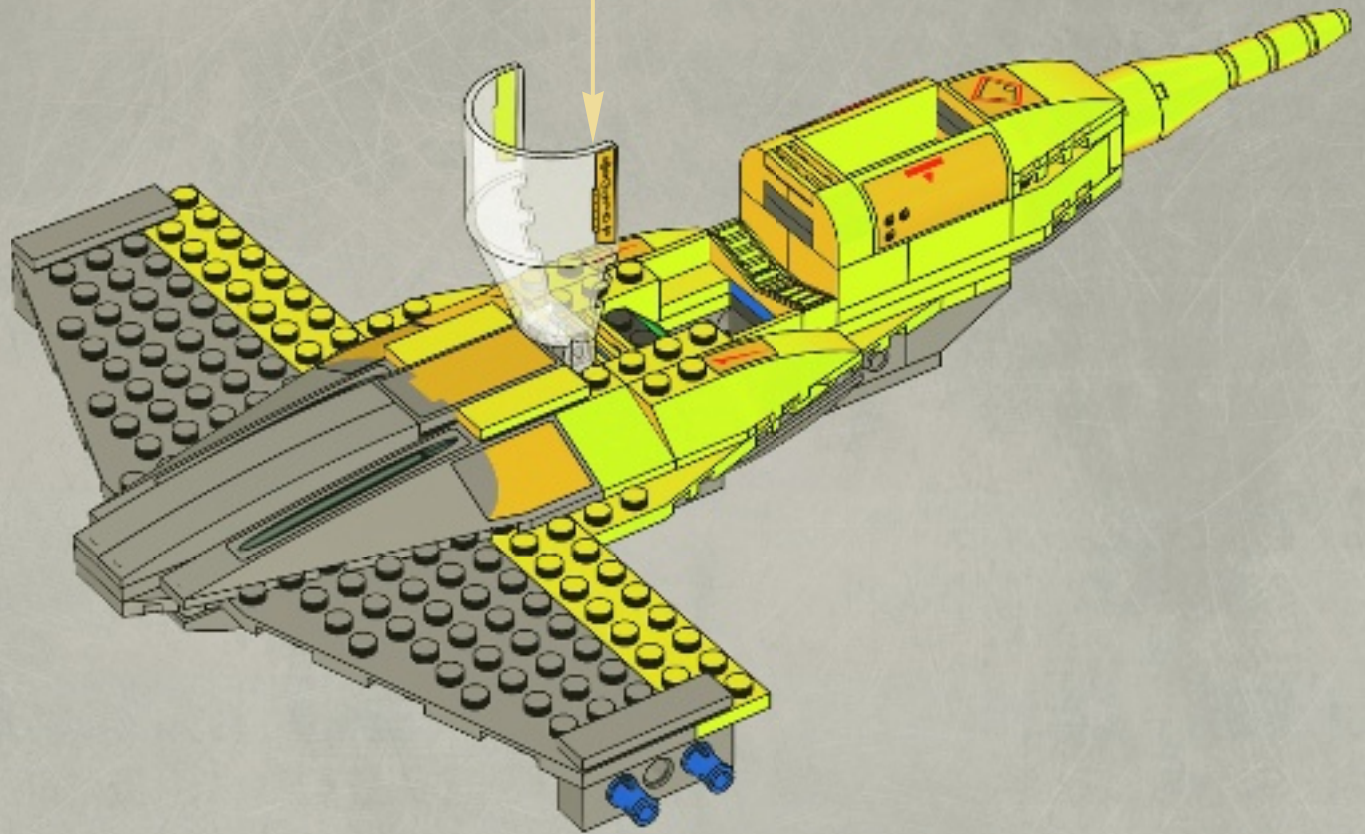

3

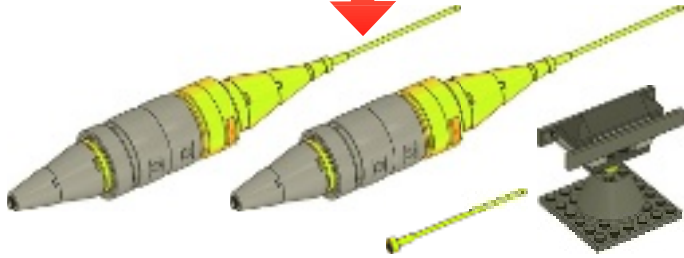

2x



1x



1x

1

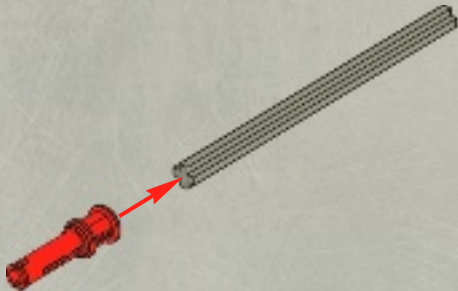

1x

2

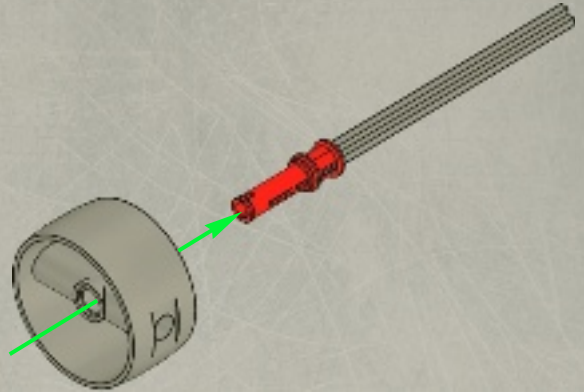

1x

3

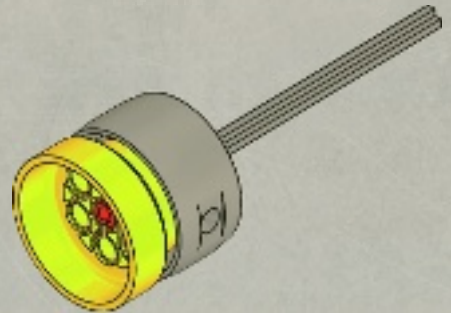



2x



2x

4

1



2



3

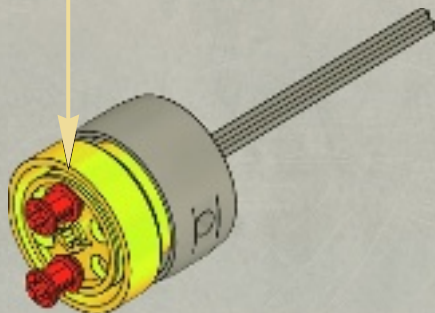
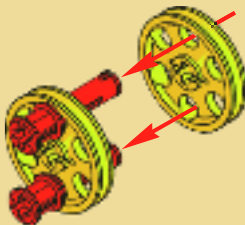

1x



2x

5

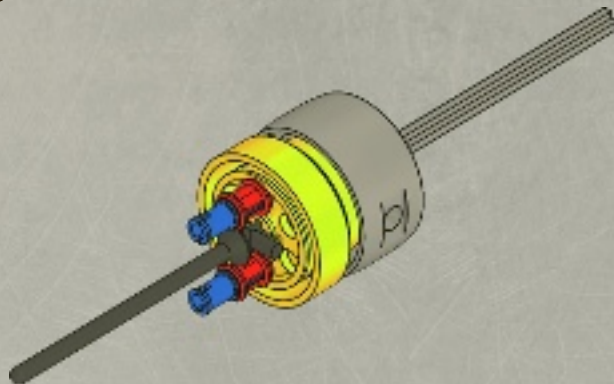

1x

6

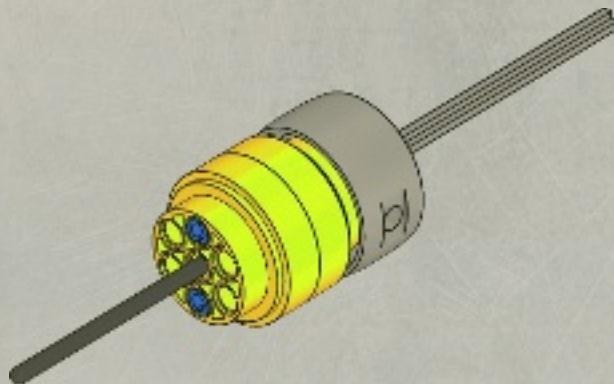



2x

7

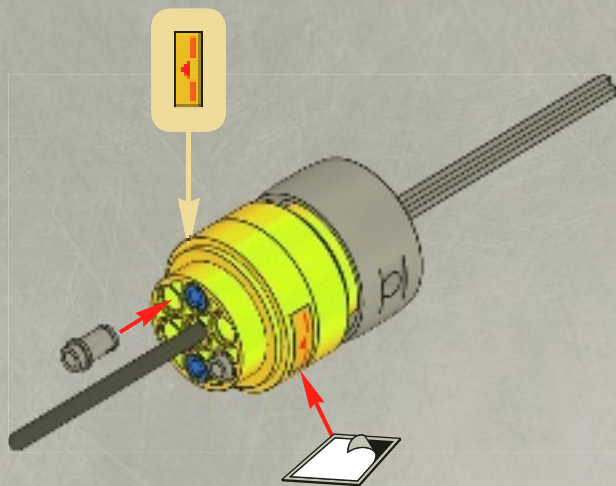

1x

8

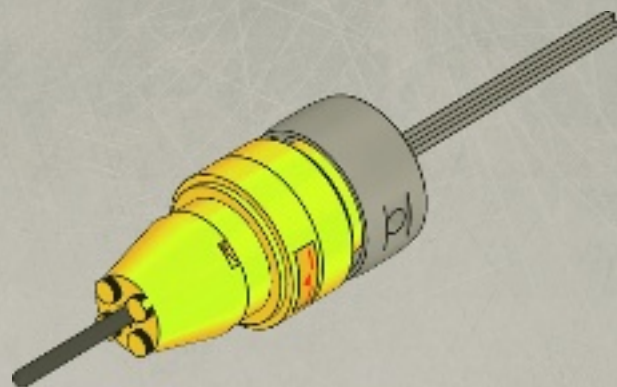



1x



1x

9

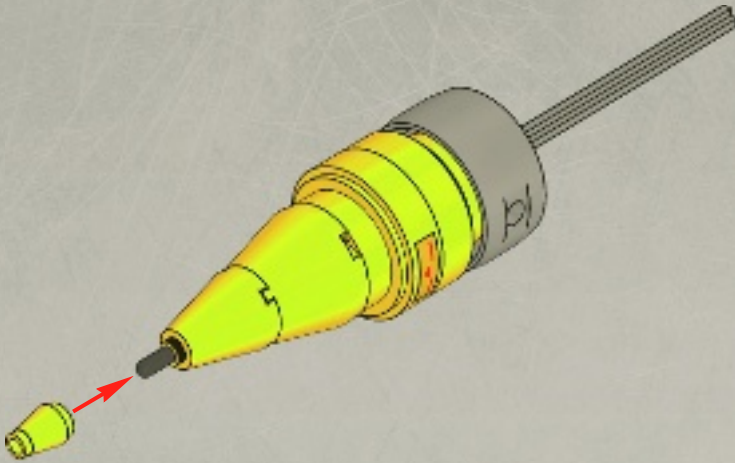

1x

10

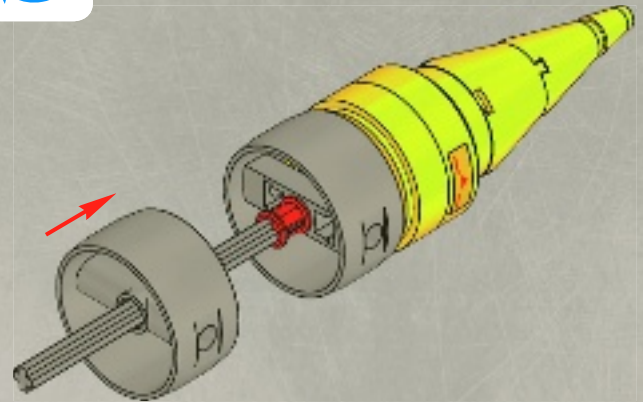



1x

11

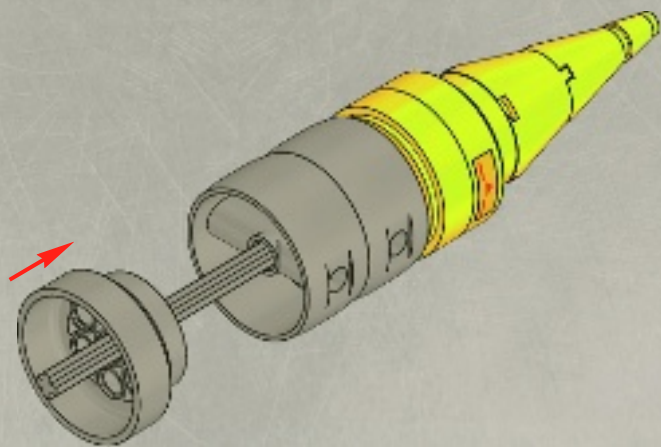

1x

12

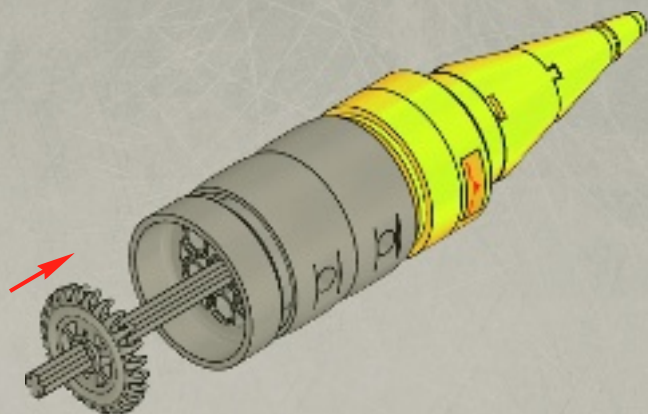



1x



1x

13

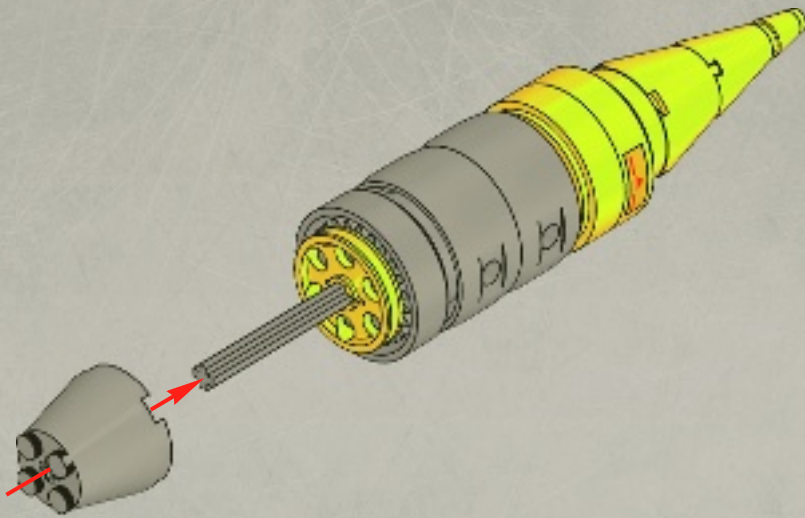

1x

14

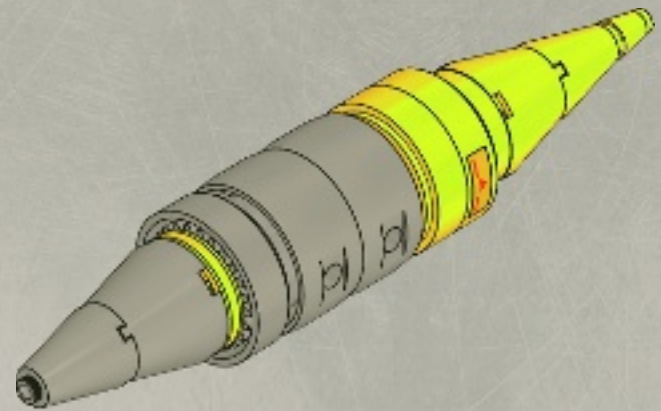

2x

39

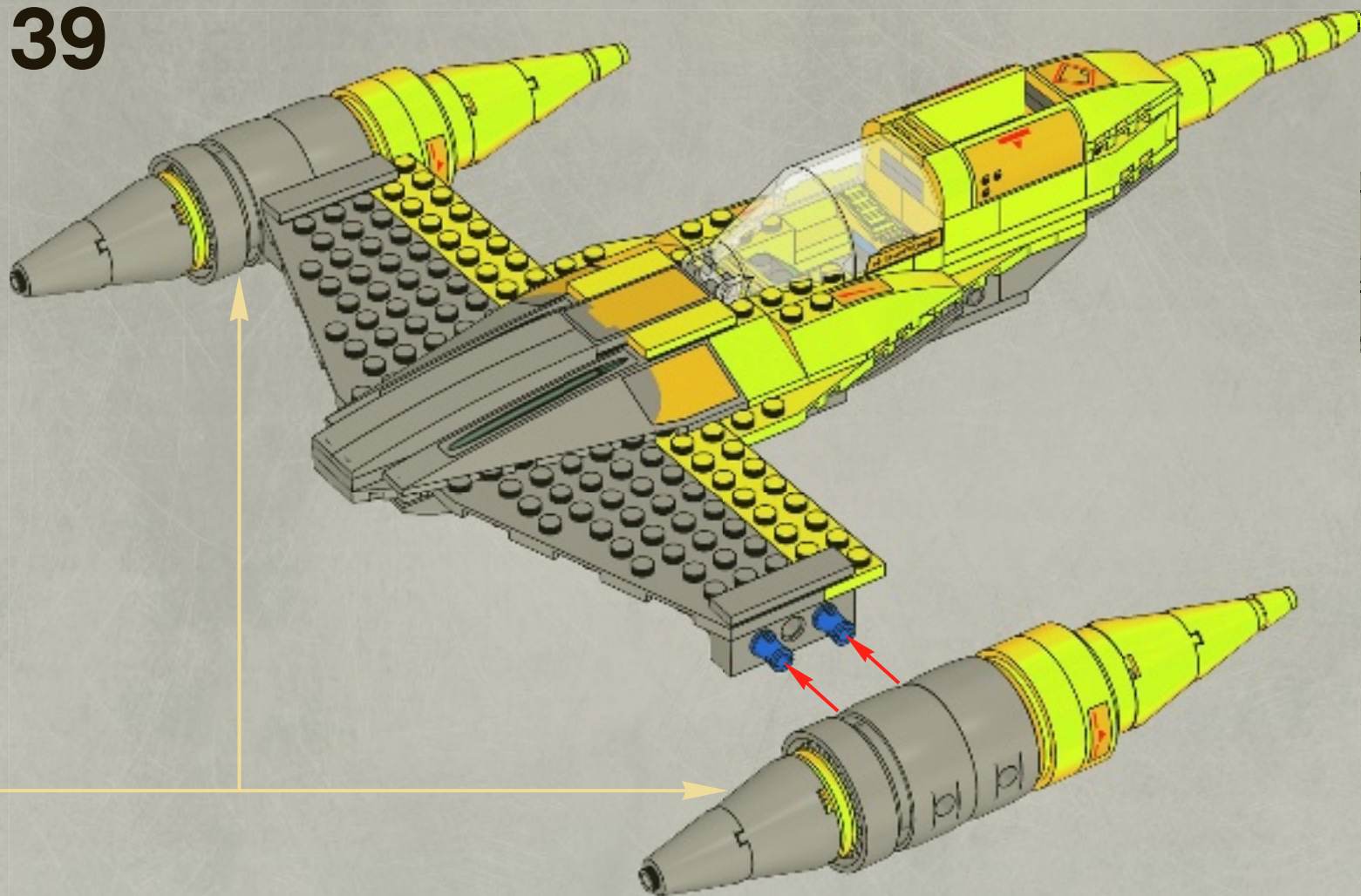



40

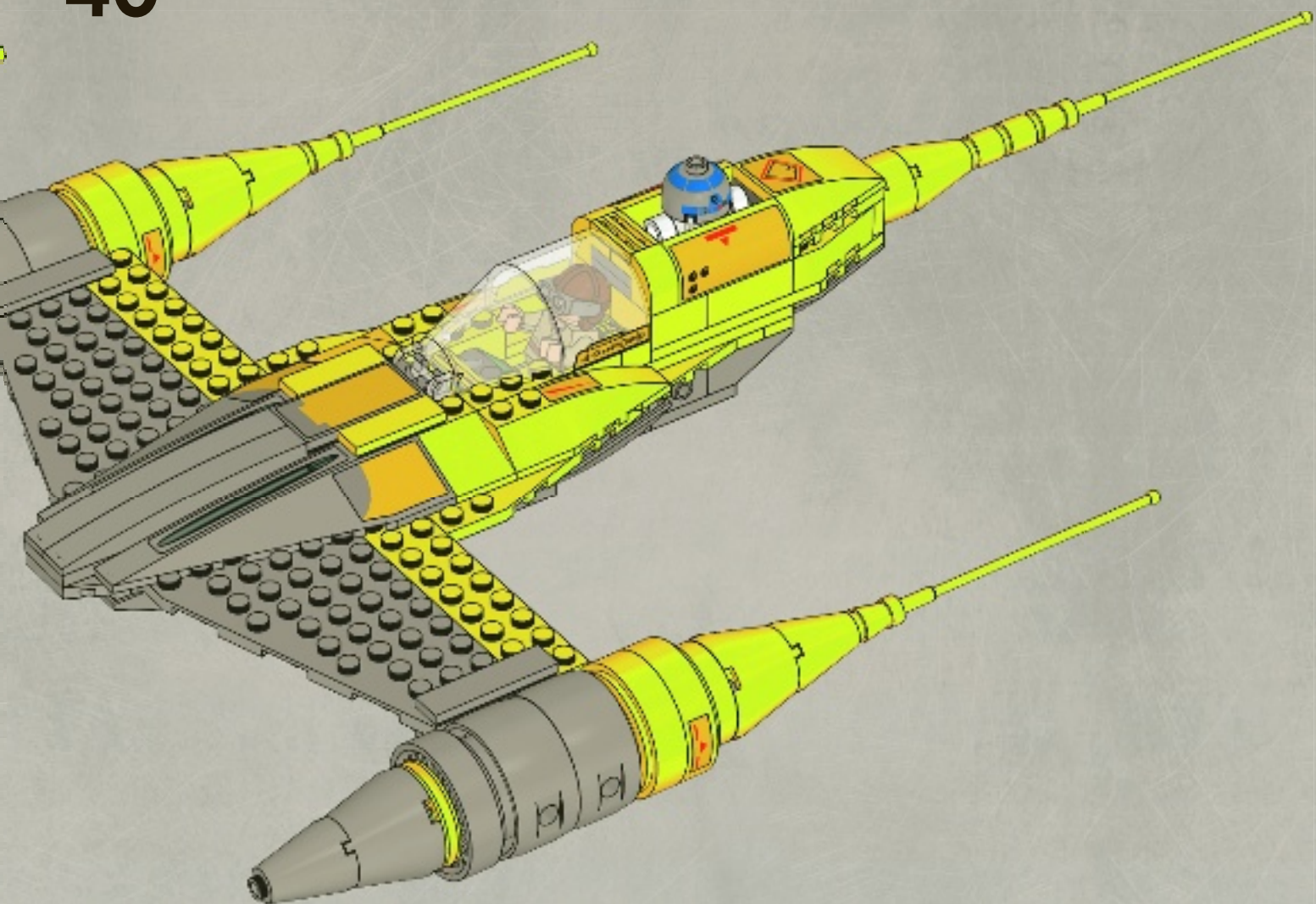



41

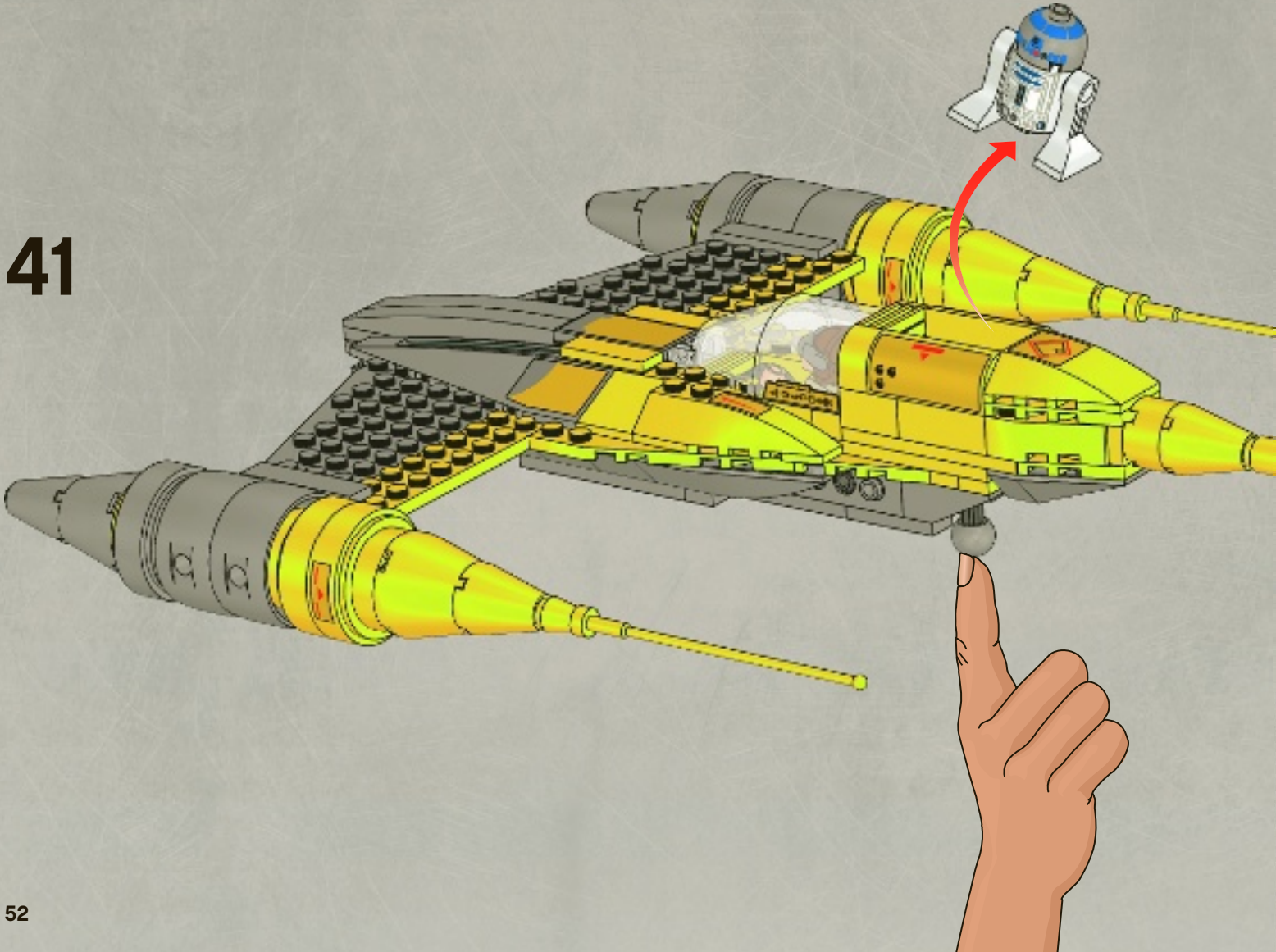



1

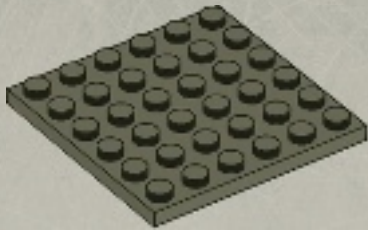

2

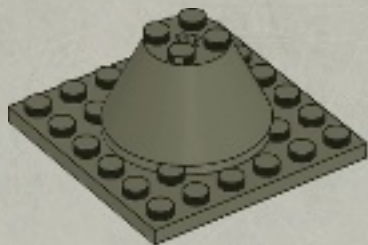

3

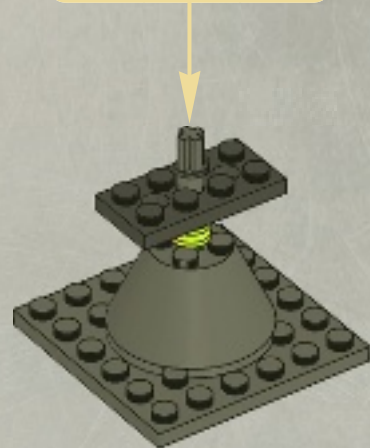
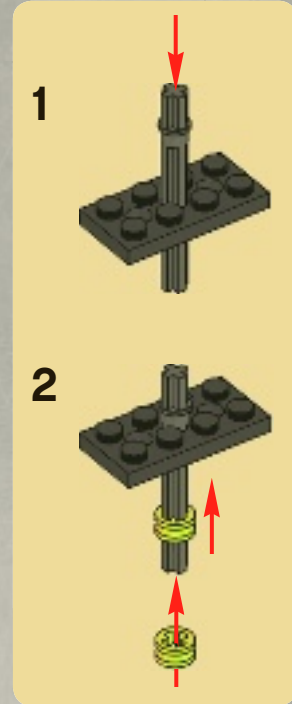



2x

4

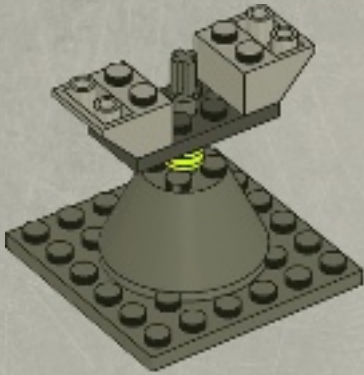

1x

5

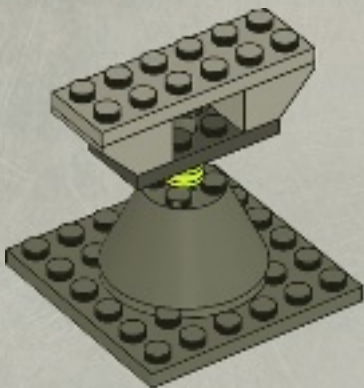

2x



2x

6

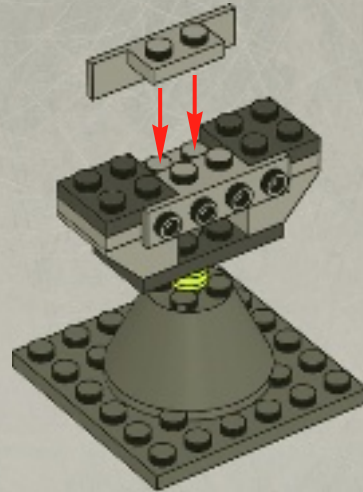

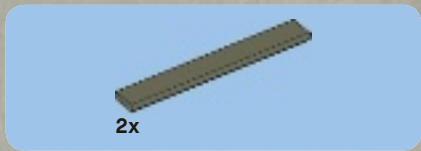

7

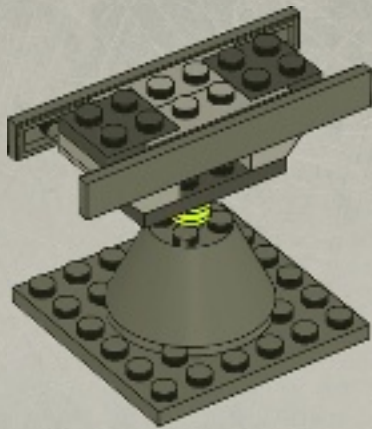

8

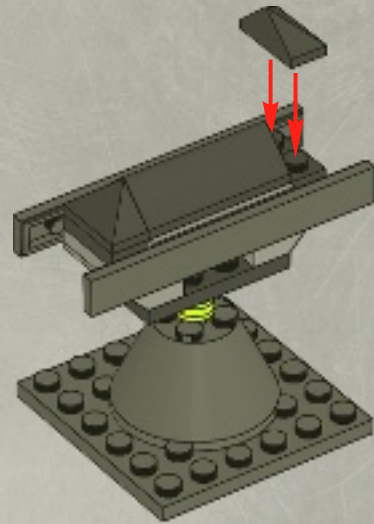

42

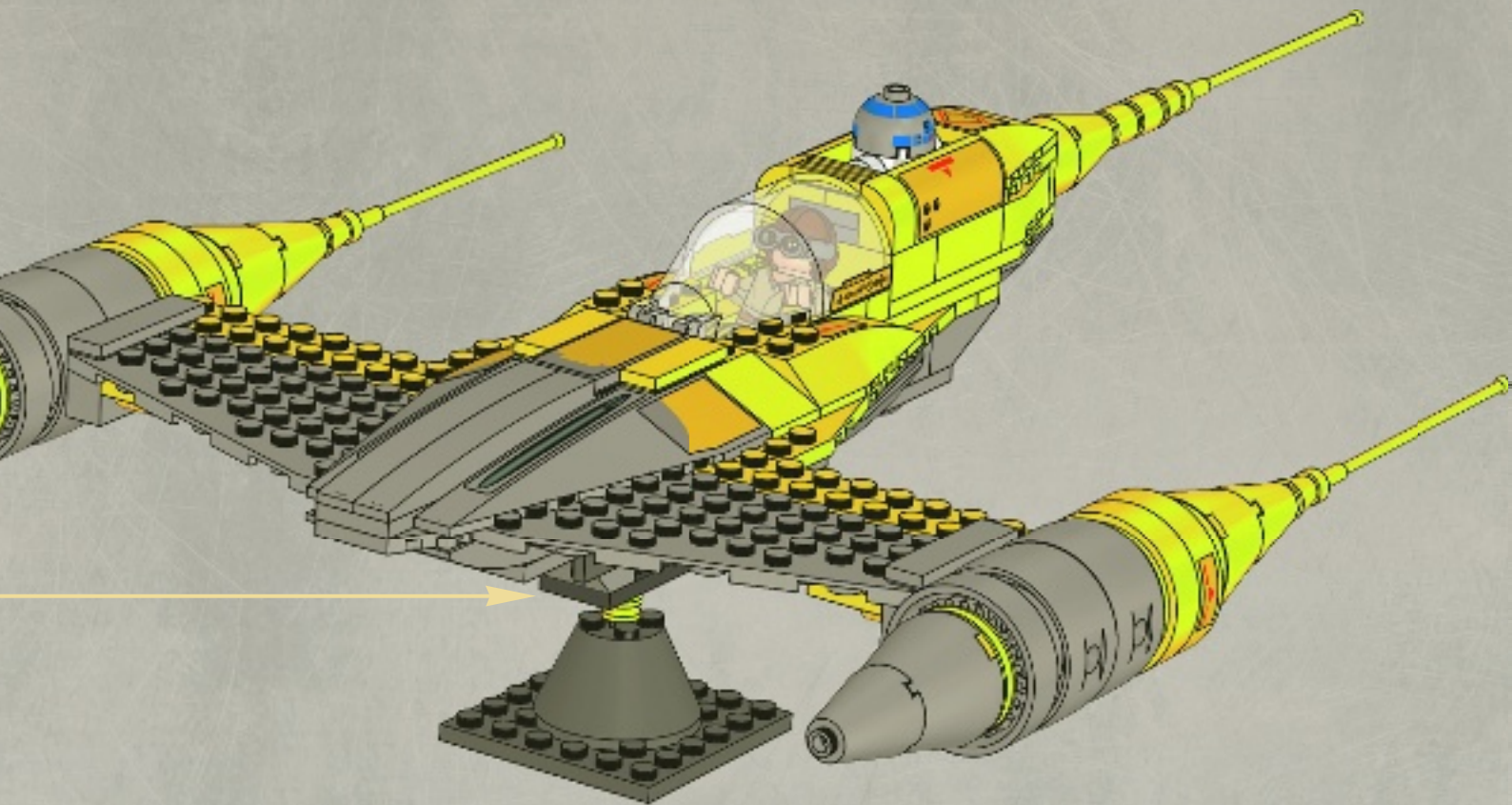

43





2x
4124113



1x
4194011



1x
4243824



1x
4114001



1x
4509897



1x
4507055



1x
4630311



2x
4508093



2x
4614790



2x
4262529



2x
4261885



1x
9342



1x
4631867



6x
4140806



4x
4504380



2x
4189123



4x
4543998



2x
243123



7x
241223



1x
4140586



2x
373823



1x
243223



4x
4206482



4x
4514553



2x
235724



4x
362224



3x
4525464



2x
306224



2x
306224



2x
306224



1x
614324



3x
394224



2x
4639063



1x
4264028



1x
370024



2x
4540384



2x
329824



2x
4188357



2x
4200030



1x
4639061



1x
4271084



1x
4271087



2x
302424



1x
4247644



1x
4247642



1x
4247642



2x
4247642



1x
306824



2x
4558172



6x
371024



4x
366624



2x
383224



2x
241224



4x
244424



2x
4161331



2x
4160868



1x
4247644



2x
4516020



1x
4514342



2x
4516020



1x
4516020



1x
4516020



1x
4516020



2x
4516020

2x
4516020



1x
4649050



2x
486524



3x
4639064



4x
4511008



6x
4494224



3x
4239601



2x
3200026



2x
304826



1x
4295400



1x
304126



6x
302226



1x
4225201



1x
4514342



2x
4516020



1x
4516020



2x
4516020



1x
4516020

2x
4516020



1x
370926



3x
4568385



1x
400626



2x
4537551



2x
4498713



1x
452226



2x
384926



1x
4630304



1x
4569486



2x
4216581



2x
4211159



1x
4520638



2x
4507049



1x
4507833



1x
4507833



1x
4507833



1x
4507833

1x
4507833

1x
4211502

1x
4533122

2x
4211471

2x
4497653

2x
4211441

2x
4211434

7x
4211436

2x
4211489

1x
4639062

2x
4211731

2x
4637573

2x
4260935

2x
4260934

1x
4505088

1x
4505087

2x
4211429

2x
4211356

1x
4560183

1x
4211438

2x
4243797

2x
4598526

2x
4556157

4x
4211452

2x
4282740

2x
4261997

1x
4507056

1x
4211617

1x
4211616

1x
4275673

4x
4221775

1x
4211628

1x
4641048

2x
4511007

4x
4507052

6x
4520320

1x
4585707

6x
4211483

3x
4211508

2x
4535768

2x
4211705

1x
4597712

1x
3006840

9x
4278412

1x
3005741

6x
4567331

1x
4507010

2x
4539063

2x
4631875

2x
4211051

2x
4211088

1x
4211024

1x
4161674

1x
4296788

1x
4210762

10x
4211063

2x
4211008

1x
4211134

9x
4626927

2x
4210645

4x
4560177

1x
4508553

Customer Service
Kundenservice
Service Consommateurs
Servicio Al Consumidor

www.lego.com/service or dial

 : 00800 5346 5555
: 1-800-422-5346





Naboo™ Pilot



Anakin Skywalker™



R2-D2™



Security Battle Droid™



Security Battle Droid™





7956



7957



7959



7961



7962



7964



7965



STAR WARS III

THE CLONE WARS™



EVERYONE 10+
E
Cade Harmon
Carzen Wolcott
LEGO, the LEGO logo and the Minifigure are trademarks of the LEGO Group. © 2005-2010 Lucasfilm Ltd. All rights reserved.

videogames.LEGO.com
www.LucasArts.com

LEGO, the LEGO logo and the Minifigure are trademarks of the LEGO Group. © 2005-2010 Lucasfilm Ltd. All rights reserved. Lucasfilm Ltd. and its subsidiaries are registered trademarks or trademarks of Lucasfilm Ltd. © 2005-2010 Lucasfilm Ltd. All rights reserved. Lucasfilm Ltd. and its subsidiaries are registered trademarks or trademarks of Lucasfilm Ltd. © 2005-2010 Lucasfilm Ltd. All rights reserved. Lucasfilm Ltd. and its subsidiaries are registered trademarks or trademarks of Lucasfilm Ltd. © 2005-2010 Lucasfilm Ltd. All rights reserved.

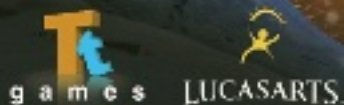

LEGO club
FREE! GRATIS! GRATUIT!



www.LEGOclub.com



LEGO Club Magazine



LEGO Club Email

VISIT THE WORLD'S
BIGGEST LEGO SHOP!

www.LEGOshop.com

00800 5346 5555

1-866-534-6258 • 1-877-518-5346

© & Controlled only

© LEGO



- * Freephone. Mobile charges may apply.
- * Numéro sans frais. Des frais peuvent s'appliquer avec les téléphones cellulaires.
- * Gebührenerfrei. Kosten für Anrufe aus Mobilfunknetzen können abweichen.
- * Gratis telefonnummer vanaf vaste lijn.
- * Det er et gratis nummer, når du ringer fra fasttelefon.
- * Det är gratis, när du ringer från en fast telefon.
- * Numéro sans frais. Des frais peuvent s'appliquer avec les téléphones portables.

BI115

YES! I want to join the LEGO® Club FREE! **OUI!** Je veux m'abonner au LEGO® Club GRATUITEMENT!

Ja! Ich möchte Mitglied im kostenlosen LEGO® Club werden. **Ja!** Ik wil graag GRATIS lid worden van de LEGO® Club.

Ja! Jeg ønsker å melde meg inn i LEGO® Club gratis! **Ja!** Jag vill gå med i LEGO® Club GRATIS!

First name • Prénom
Vorname • Voornaam
Fornavn • Förnamn

Last name • Nom de famille
Name • Achternaam
Efternavn • Efternamn

Date of Birth • Date de naissance
Geburtsdag • Geboortedatum
Fødselsdato • Födelsedatum

Boy • Garçon
Junge • Jongen
Gutt • Pojk

Girl • Fille
Mädchen • Meisje
Jente • Flicka

Street • Adresse
Straße, Hausnr.
Straat, huisnr. • Adress

City • Ville
Ort • Woonplaats
Poststed • Postort

State
Prov. • Provincie

Country
Pays
Land

Zip/Postcode
Code Postal • PLZ
Postcode
Postnummer

Email • Courriel
E-Mail • E-post

- Fill in your email address and we will send you a membership confirmation and monthly email newsletters. If you do not wish to receive the newsletters please tick here. Remplis ton adresse e-mail et nous t'enverrons une confirmation d'adhésion ainsi que le bulletin e-mail mensuel. Si tu ne désires pas recevoir le bulletin, coche cette case. Vul je e-mailadres in en we sturen je een bevestiging van je lidmaatschap en maandelijke e-mail nieuwsbrieven. Als je geen e-mail wilt ontvangen, kruis dan dit vakje aan.
- Ich möchte per E-Mail den monatlichen LEGO Club Newsletter erhalten. Ønsker du at vi skal sende en liten hilsen til barnet ditt for å bekrefte medlemskapet, ber vi deg krysse av i feltet, samt oppgi e-postadressen som hilsenen skal sendes til. Om du vill at vi et ska skicka en bekräftelse på ditt barns medlemskap, ber vi dig sätta ett kryss i rutan och skriva den e-post adress som bekräftelsen ska skickas till.
- If you do not wish to receive additional mailings from the LEGO Club please tick here. Si tu ne désires pas recevoir de courrier supplémentaire du Club LEGO, coche cette case. Als je geen verdere post van de LEGO Club wilt ontvangen, kruis dan dit vakje aan.
- Dersom du ønsker å motta annen informasjon fra LEGO Gruppen, setter du et kryss her.

Mail to: / Poster à:



LEGO® Club
P.O. Box 1157
Enfield, CT USA
06083-1157

Per Post an:



LEGO® Club
Postfach 14 15
D-36243 Niederaula

Send til:



LEGO® Club Norge
Postboks 58
1314 Vøyenenga

Mail to:



LEGO® Club
33 Bath Road
Slough SL1 3UF
United Kingdom

Stuur op naar:



LEGO® Club
Postbus 40250
3504 AB Utrecht

Skickas till:



LEGO® Club Sverige
Ubox 841
202 29 Malmö

Poster à:



LEGO® Club
21 rue de la banque
75 002 PARIS
FRANCE

The English language version of the magazine can only be mailed to addresses in the US, Canada, the UK, and Republic of Ireland. Club membership is valid for two years and includes free copies of the LEGO Club Magazine and e-mail newsletters. In the US and Canada please allow up to 6 weeks for delivery of your first magazine. In the UK and Republic of Ireland please allow six to 14 weeks for delivery of your first magazine. By signing this form you consent the LEGO Club to use your child's data for the LEGO mailings. The data will only be used for LEGO mailings and will not be sold, rented or otherwise disclosed to any company outside the LEGO Company except for companies acting as our agents to help us provide services requested by the child. This coupon is valid for one free membership per person, group or organization. Photocopied coupons are accepted. The version française du magazine peut être postée uniquement au Canada. L'abonnement est valide pour 2 ans et inclut des exemplaires gratuits du Magazine LEGO. Aux É.-U. et au Canada, allouer 6 semaines pour la livraison initiale. En remplissant ce formulaire, vous consentez à ce que LEGO utilise les informations de votre enfant pour des envois postaux de LEGO. L'information sera utilisée uniquement pour des envois postaux par LEGO et ne sera en aucun cas, vendue, louée, échangée ou divulguée à d'autres compagnies autres que la compagnie LEGO, à l'exception des compagnies affiliées qui nous procurent des services auxuels enfant en a fait la demande. Formulaires photocopiés acceptés. Mit der folgenden Unterschrift erkläre ich, für mein Kind den Beitritt als Mitglied zum kostenlosen LEGO Club, der von der LEGO GmbH, D-85627 Grasbrunn, betrieben wird. Die Mitgliedschaft beinhaltet die Zusendung des LEGO Club Magazins und kann beiderseits jederzeit beendet werden. Mit der Mitgliedschaft im LEGO Club sind keinerlei Verpflichtungen verbunden. Das deutschsprachige LEGO Club Magazin wird nur an Adressen in Deutschland, Österreich und der Schweiz versendet. Eine Anmeldebestätigung kann nur per E-Mail geschickt werden. Das Magazin erscheint fünfmal jährlich. Daher kann die Zustellung des ersten Heftes bis zu drei Monate dauern. Die Mitgliedschaft ist beidseitig jederzeit kündbar, ohne dass Ihnen Kosten entstehen. Sie können der werblichen Nutzung Ihrer Daten jederzeit widersprechen. Kündigung und Widerspruch können Sie telefonisch erklären (00800 / 5346 5555, Anruf gebührenfrei, Kosten für Anrufe aus dem Mobilfunknetz können abweichen) oder an die LEGO GmbH senden. Het Nederlandse LEGO Club Magazine kan alleen worden gestuurd naar adressen in Nederland. Het lidmaatschap is 2 jaar geldig en geeft recht op toezending van het gratis LEGO Club Magazine en LEGO Club e-mails. Het eerste magazine zal binnen 12 tot 14 weken toegestuurd worden. Het lidmaatschap kan op ieder moment opgezegd worden en kan na 2 jaar gratis worden verlengd, tenzij LIGO de deze activiteit stopt. Uw gegevens worden uitsluitend gebruikt voor mailings van LEGO en zullen niet worden verkocht, verhuurd of op welke wijze dan ook verstrekt aan derden buiten de LEGO Groep, uitgezonderd de organisaties die namens ons optreden om de informatie te sturen waarvoor toestemming is verleend. Den norske utgaven av magasinet sendes kun til adresser i Norge. Medlemskap i klubben gjelder i 2 år og inkluderer gratisutgaver av LEGO Club Magazine. Prøven minimum opp til seks uker leveringstid for første magasin. Ved å undertegne dette skjemaet, gir du ditt samtykke til at LEGO Club kan bruke opplysningene om barnet ditt i LEGO forsendelser. Dataene vil utelukkende bli brukt i LEGO forsendelser og vil ikke bli solgt, utleid eller på annen måte gjøres tilgjengelig for selskaper utenfor LEGO gruppen, unntatt selskaper som er våre agenter og som hjelper oss å tilby tjenestene barnet etterpør. Dette skjemaet gjelder for ett gratis medlemskap per person, gruppe eller organisasjon. Den svenska versionen av tidningen kan endast skickas till adresser i Sverige. Club-medlemskapet är giltigt i 2 år och innefattar gratis exemplar av LEGO Club Magazine. Vänligen räkna med minimum 6 veckor för leverans av din första tidning. Genom att skicka in det här formuläret godkänner du att LEGO Club använder barnets uppgifter för LEGO utskick. Uppgifterna kommer bara att användas för LEGO utskick och kommer inte att säljas, hyras ut eller vidarebefordras till något företag som inte tillhör LEGO Gruppen, med undantag av företag som agerar som våra ombud för att tillhandahålla tjänster som barnet har begärt. Den här kupongen gäller för ett gratis medlemskap per person, grupps eller organisation. En complétant ce bulletin d'adhésion, vous acceptez que LEGO Club utilise les données relatives à votre enfant pour l'envoi de courriers concernant LEGO. Ces données seront uniquement utilisées pour l'envoi d'information concernant LEGO et ne seront ni vendues, ni louées, ni utilisées par d'autres sociétés que le groupe LEGO, à l'exception des sociétés agissant pour le compte de LEGO en tant que sous-traitant de services divers. L'abonnement au LEGO Club est valable pour une période de 2 ans. Il inclut l'envoi par courrier du magazine LEGO Club et par email des newsletters. Un délai de 6 à 14 semaines est à prévoir pour la réception de votre premier magazine. Ce bulletin d'adhésion est valable pour l'inscription d'une seule personne. Les photocopies sont acceptées. ATTENTION! Le bulletin d'adhésion doit être rempli et signé par un parent ou un tuteur.

Parent's signature • Signature d'un parent ou d'un tuteur •
Unterschrift Erziehungsberechtigte/ • Handtekening ouders •
Forelders/foresattes underskrift • Förälders/förmyndares underskrift

Date
Datum



WIN!

Go to www.LEGOsurvey.com/product
to fill out a survey for a chance
to win a cool LEGO® Product.
No purchase necessary.
Open to all residents where not prohibited.



www.LEGOsurvey.com/product

GEWINNE! WIN!

Nimm an der Umfrage auf
www.LEGOsurvey.com/product
teil und hab die Chance ein cooles
LEGO® Produkt zu gewinnen!

Die Teilnahme am Gewinnspiel führt zu keinerlei
Kaufverpflichtungen. Teilnahme in allen nicht
ausgeschlossenen Ländern möglich.

Ga naar www.LEGOsurvey.com/product,
vul een enquêteformulier
in en maak kans op een
cool LEGO® product.

Geen aankoopverplichting.
Iedereen mag deelnemen, uitgezonderd
ingezetenden van landen waar een
enquêteverbod geldt.

GAGNE! 当てよう!

Visite www.LEGOsurvey.com/product
pour répondre à un
questionnaire et avoir une chance de
gagner un produit LEGO® très cool!

Aucune obligation d'achat.
Ouvert à tous les résidents des pays
autorisés.

www.LEGOsurvey.com/product にアクセスして、
アンケートにご記入ください。当選者にはレゴ®
製品を差し上げます。

お買い上げの必要はありません。
禁止されていない限り、すべての皆様にご利用いただけます。

LEGO and the LEGO logo are trademarks of the/son des marques de commerce de/
son marcas registradas de LEGO Group. ©2011 The LEGO Group.

© 2011 LucasFilm Ltd. & TM. All rights reserved. /Tous droits réservés. /Todos los derechos reservados.